

CATALOGUES

Bitte fordern Sie unsere
entsprechenden Kataloge an.

Please request for our
appropriate catalogues.

Por favor pidan por nuestros
catálogos apropiados.

Veillez demander nos
catalogues appropriés.

Vogliate richiedere i nostri
cataloghi adatti.

>> Unser Lieferprogramm

Allgemeinchirurgie
Gynäkologie, Geburtshilfe und Urologie
Plastische Chirurgie und HNO
Thorax, Herz und Gefäßchirurgie
Neurochirurgie
Ophthalmologie
Endoskopie
Container und Sterilisation
Dental und Oral

>> Our product range

General Surgery
Gynecology, obstetrics and urology
Plastic Surgery and ENT
Thoracic and cardiovascular surgery
Neurosurgery
Ophthalmology
Endoscopy
Container and Sterilization
Dental and Oral

>> Nuestra gama de productos

Cirugía general
Ginecología, obstetricia y urología
Cirugía plástica y ORL
Cirugía torácica y cardiovascular
Neurocirugía
Oftalmología
Endoscopia
Contenedor y esterilización
Odontología y oral

>> Notre gamme

Chirurgie générale
Gynécologie, obstétrique et urologie
Chirurgie plastique et ORL
Chirurgie thoracique et cardiovasculaire
Neurochirurgie
Ophtalmologie
Endoscopie
Conteneur et stérilisation
Dental et Oral

>> Nostro programma di produzione

Chirurgia generale
Ginecologia, ostetricia e urologia
Chirurgia plastica ed ORL
Chirurgia toracica e cardiovascolare
Neurochirurgia
Oftalmologia
Endoscopia
Contenitore e sterilizzazione
Odontoiatria e Orale

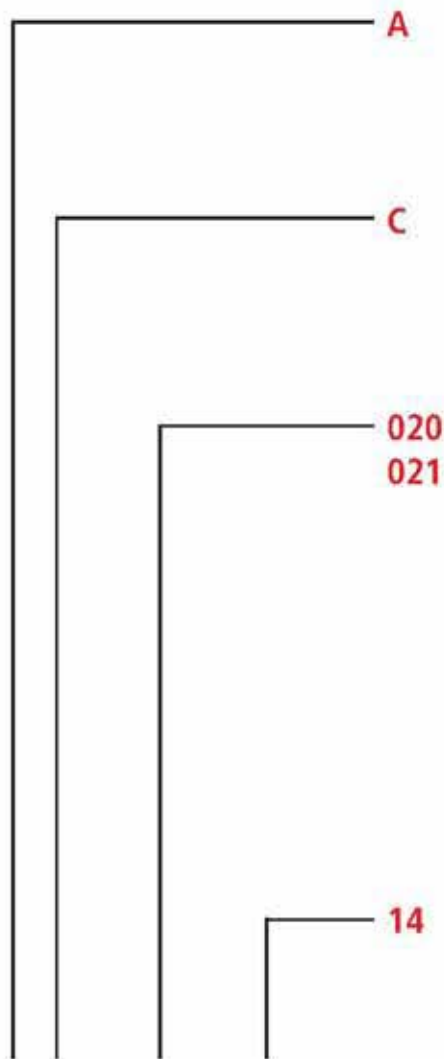

Artikelcode **AC 020/14**

Allgemeines Instrumentarium

General Instruments
Instrumental Général
Instruments Générales
Strumenti generali

Scheren

Scissors
Tijeras
Ciseaux
Forbici

Fortlaufende Nummern

Gerade Ziffer = gerades Instrument
Ungerade Ziffer = gebogenes Instrument

Continuous number

Even number = straight instrument
Odd number = curved instrument

Número de orden

números pares = instrumento derecho
números impares = instrumento curvado

Numéros d'ordre

numéro pair = instrument droit
numéro impair = instrument courbe

Numeri progressivi

numero pari = strumento retto
numero dispari = strumento curvo

Länge oder Figur

Length or Figure
Longitud o figura
Longueur ou figure
Lunghezza o figura

INDEX SETS

ZS 160/00	>> Notfall • Emergency • emergencia • urgence • emergenza	11-16
ZS 160/05	>> Fremdkörper • Foreign Body • cuerpo extraño • corps étranger • corpo estraneo	17
ZS 160/10	>> Nahtentfernung • Stitch Removal • retiro de suturas • enlèvement de suture • togliere la sutura	18
ZS 160/15	>> Strabismus / Muskel • Strabismus / Muscle • estrabismo / musculo • strabismo / muscle • strabismo / muscolo	19-22
ZS 160/20	>> Chalazion • Chalazion • chalazión • chalazion • calazio	23-24
ZS 160/25	>> Enukleation • Enucleation • enucleación • énucléation • enucleazione	25-28
ZS 160/30	>> Glaukom • Glaucoma • glaucoma • glaucome • glaucoma	29-32
ZS 160/35	>> Katarakt E.C. • Cataract E.C. • catarata E.C. • cataracte E.C. • cataratta E.C.	33-38
ZS 160/40	>> Katarakt Linse • Cataract Phacoemulsification • catarata facoemulsificación • cataracte phacoémulsification • cataratta facoemulsificazione	39-44
ZS 160/45	>> Keratoplastik • Keratoplasty • queratoplastia • kératoplastie • cheratoplastica	45-48
ZS 160/50	>> Keratomie astigmatisch • Astigmatic Keratotomy • queratoplastia astigmatismo • kératotomie astigmaté • cheratotomia astigmatica	49-50
ZS 160/55	>> Netzhautablösung • Retinal Detachment • desprendimiento de retina DR • décollement de la rétine • distacco della retina	51-56
ZS 160/60	>> Lid-Konjunktiva • Lid-Conjunctiva • conjunctiva • paupière-conjonctive • congiuntiva	57-60
ZS 160/65	>> Pterygium • Pterygium • pterigiòn • ptérygion • pterigio	61-62
ZS 160/70	>> Dacryocystorhinostomie • Dacryocystorhinostomy • dacriocistorinostomia • dacryocystorhinostomie • dacriocistorinostomia	63-66
ZS 160/75	>> Lasik • Lasik • lasik • lasik • lasik	67-68
ZS 160/80	>> Radiäre Keratotomie • Radiale Keratotomy • queratotomía radial • kératotomie radiale • cheratotomia radiale	69-70
ZS 160/85	>> Vitrektomie (Pars Plana) • Vitrectomy (Pars Plana) • vitrectomía pars-plana • vitrectomie (pars plana) • vitrectomia pars-plana	71-74

INDEX INSTRUMENTS

>> Klemmen • Hemostats • Pinzas hemostáticas Pincas hémostatiques • Pinze emostatiche	75-80	AA
>> Pinzetten • Forceps • Pinzas • Pincas • Pinze	81-98	AB
>> Scheren • Scissors • Tijeras • Ciseaux • Forbici	99-118	AC
>> Skalpelle • Scalpels • Bisturies • Bistouris • Bisturi	119-124	AD
>> Naht • Suture • Sutura • Suture • Sutura	125-134	AE
>> Wundhaken • Retractors • Separadores • Ecarteurs • Divaricatori	135-140	AK
>> Diagnostik • Diagnostics • Diagnóstico • Diagnostic • Diagnostica	141-144	AR
>> Ophthalmologie • Ophthalmology • Oftalmologia Ophthalmologie • Oftalmologia	145-206	KP
>> Endoskopie • Endoscopy • Endoscopia • Endoscopie • Endoscopia	207-210	XR

KYE

- >> Bitte fordern Sie unseren Spezialkatalog für Sterilisationscontainer an.
- >> Please request for our special catalogue for Sterilization Containers.
- >> Por favor pida por nuestro catálogo especial de contenedores de esterilización.
- >> Nous vous prions de demander notre catalogue spécial des conteneurs de stérilisation.
- >> Chieda prego il nostro catalogo per contenitori di sterilizzazione.

Contents:		Qty
AA 060/03	DIEFFENBACH BULLDOG CLAMPS STR 3,5 CM	2
AA 150/12	HALSTED-MOSQUITO FCPS STR 12,5 CM	2
AA 151/12	HALSTED-MOSQUITO FCPS CVD 12,5 CM	2
AA 711/09	JONES TOWEL FORCEPS 9,0 CM	2
AB 710/10	GRAEFE IRIS FORCEPS STR SERR. 10,0 CM	1
AB 734/01	BONN IRIS FORCEPS W.GUIDE PIN 1X2T. 7,0 CM	1
AB 738/08	BISHOP-HARMAN IRIS FORCEPS 1X2 T. 8,5 CM	1
AB 750/07	BARRAQUER-KATZIN FIX.FCPS 1X2 T. 7,0 CM	1
AB 796/02	LESTER FIXATION FORCEPS 1X2 TEETH 9,0 CM	1
AB 816/01	CASTROVIEJO SUTURE FORCEPS 0,12 MM 10,0 CM	2
AB 820/10	KELMAN-MCPHERSON TYING FORCEPS 10,0 CM	1
AB 828/10	PAUFIQUE SUTURE FORCEPS 1X2 TEETH 10,0 CM	1
AC 431/08	MOD.BONN SCISSORS CVD 8,0 CM	1
AC 466/10	IRIS SCISSORS STR W LARGE BOWS 10,0 CM	1
AC 475/11	STEVENS TENOTOM.SCS.CVD POINTED 11,5 CM	1
AC 768/05	BARRAQUER EYE SCISSORS 5,5 CM 5 MM	1
AC 782/11	WESTCOTT TENOTOMY SCISSORS BLUNT 11,0 CM	1
AC 797/01	WESTCOTT STRABISMUS SCS STR SHARP 11,5 CM	1
AD 540/00	RAZER BLADES, PACKING UNIT 10 PIECES	1
AD 550/09	BLADE BREAKER 9.0 CM DIA 5,5 MM	1
AE 600/10	BARRAQUER-TROUTMAN MICRO-NH STR RA 10,0 CM	1
AE 602/10	BARRAQUER-TROUTMAN MICRO-NH STR 10,0 CM	1
AE 660/14	CASTROVIEJO NH STR RA SMOOTH 14,0 CM	1
AK 090/10	DESMARRES RETRACTOR 10 MM 13,0 CM	1
AK 090/12	DESMARRES RETRACTOR 12 MM 13,0 CM	1
AK 090/14	DESMARRES RETRACTOR 14 MM 13,0 CM	1
AR 250/15	MEASURING INSTRUMENT 15,0 CM	1
AR 282/20	CASTROVIEJO CIRCLE 8,0 CM STRAIGHT	1
KP 002/12	JAMESON MUSCLE HOOK 12,0 CM	1
KP 010/14	GASS RETINAL DETACHMENT HOOK 14,0 CM	1
KP 015/02	GRAEFE STRABISMUS HOOK #2 14,0 CM	1
KP 018/12	STEVENS TENOTOMY HOOK 12,0 CM	1
KP 023/01	FIXATION HOOK RIGHT 11,0 CM	1
KP 150/05	BARRAQUER-COLIBRI EYE SPECULA 5,0 MM 3,0 CM	1
KP 150/10	BARRAQUER-COLIBRI EYE SPECULA 10,0 MM 3,0 CM	1
KP 154/04	BARRAQUER PHACO EYE SPECULA 4,0 CM	1
KP 212/08	LIEBERMAN EYE SPECULA 15,0 MM 8,0 CM	1
KP 280/14	SCHOCKET SCLERAL DEPRESSOR 14,0 CM	1
KP 542/01	SCHIOETZ TONOMETER STRAIGHT SCALE	1
KP 700/00	BISHOP-HARMON ANTERIOR CHAMBER	1
KP 731/27	SAUTTER AIR INJECTION CANNULA 27G 3,5 CM	1
SK 305/05	WIRE BASKET, 485 X 255 X 50 MM	1

Sterilization Container KYE 200/61, if required



DIEFFENBACH
AA 060/03
3,5 cm/1 1/2"



HALSTED-MOSQUITO
AA 150/12 AA 151/12
12,5 cm/5"



JONES
AA 711/09
9,0 cm/3 1/2"



GRAEFE
AB 710/10
10,0 cm/4"



MOD. BONN 1:2
AB 734/01
7,0 cm/2 3/4"



10x

mit Führungsstift
with guide pin
con espiga de guía
avec repères
con perno da guida

Irispinzette
Iris Forceps
Pinzas para Iris
Pinces à iris
Pinze per iride



BISHOP-HARMAN 1:2
AB 738/08
8,5 cm/3 1/3"



BARRAQUER-KATZIN 1:2
(Colibri)
AB 750/07
7,0 cm/2 3/4"



LESTER
AB 796/02
9,0 cm/3 1/2"



CASTROVIEJO 1:2
AB 816/01
0,12 mm
10,0 cm/4"



KELMAN-McPHERSON 1:2
AB 820/10
10,0 cm/4"



PAUFIGUE 1:2
AB 828/10
10,0 cm/4"

mit großen Ringen
with large bows
con anillos grandes
avec grands anneaux
con anelli grandi

Sehnenscheren
Tenotomy Scissors
Tijeras para tenotomía
Ciseaux à ténatomie
Forbici per tenotomia

spitz
pointed
agudas
pointues
acuta

gebogen
curved
curvas
courbes
curve

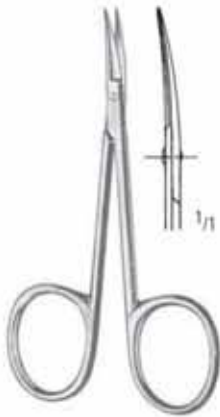

MOD. BONN
AC 431/08
8,0 cm/3"



AC 466/10
10,0 cm/4"



STEVENS
AC 475/11
11,5 cm/4 1/2"



BARRAQUER
5,5 cm/2 1/4"
5 mm AC 768/05

RASIERKLINGEN, VERPACKUNGSEINHEIT 10 STCK
RAZOR BLADES, PACKING UNIT 10 PIECES
HOJAS DE AFEITAR, UNIDAD DE VENTA 10 PZ
LAMES DE RASOIR, UNITÉ À 10 PIÈCES
LAMETTE DA BARBA, UNITÀ DI VENDITA 10 PZ



AD 540/00



TROUTMAN-CHRIS
AD 550/09
Ø 5,5 mm
9,0 cm/3 1/2"



BARRAQUER-TROUTMAN
AE 600/10
10,0 cm/4"



BARRAQUER-TROUTMAN
AE 602/10
10,0 cm/4"



CASTROVIEJO
AE 660/14
14,0 cm/5 1/2"



DESMARRES
13,0 cm/5"

AK 090/10
10 mm

AK 090/12
12 mm

AK 090/14
14 mm



AR 250/15
15,0 cm/6"

Messbereich 20 mm
measuring range 20 mm
campo de medición 20 mm
étendue de mesurage 20 mm
ampiezza di misura 20 mm



CASTROVIEJO
AR 282/20
8,0 cm/ 3"



JAMESON
KP 002/12
12,0 cm/4³/₄"



GASS
KP 010/14
14,0 cm/5¹/₂"



GRAEFE
KP 015/02
14,0 cm/5¹/₂"
Fig. 2



STEVENS
KP 018/12
12,0 cm/4³/₄"



rechts
right
derecha
droit
destra

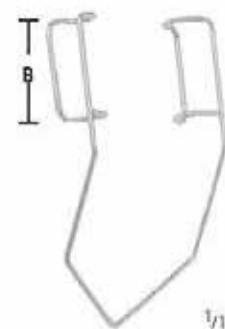

BARRAQUER-COLIBRI

B
5 mm KP 150/05
3,0 cm/1¹/₄"

Frühgeborene
Premature infant
Parto prematuro
Accouchement prématuré
Parto prematuro

10 mm KP 150/10
3,0 cm/1¹/₄"

Kind
Child
Niños
Enfants
Bambini

KP 023/01
11,0 cm/4¹/₂"



BARRAQUER PHAKO
KP 154/04
4,0 cm/1¹/₂"



LIEBERMAN
KP 212/08
8,0 cm/3¹/₄"
B = 15 mm



SCHOCKET
KP 280/14
14,0 cm/5 1/2"



gerade Skala
straight scale
graduado recto
échelle droite
scala retta

SCHIOETZ
KP 542/01
13,0 cm/5"

Spezifikation Nr. 5, geeicht
Specification No. 5, calibrated
Especificación No. 5, calibrada
Spécification No. 5, calibrée
Specifica No. 5, calibrata

Set komplett
Set complete
Juego completo
Jeu complet
Set completo



BISHOP-HARMON
KP 700/00



SAUTTER
KP 731/27
3,5 cm/1 1/2"
27G



L(mm)	B(mm)	H(mm)	
485	255	50	SK 305/05

Contents:

Qty

KP 150/15	BARRAQUER-COLIBRI EYE SPECULA 15 MM 4,0 CM	1
KP 350/12	FOREIGN BODY INSTRUMENT	1
KP 415/10	MEYHOEFER CHALAZION CURETTE	1
SX 432/01	SILICON MAT 275 X 125 MM	1

Sterilization container KYE 351/01, if required

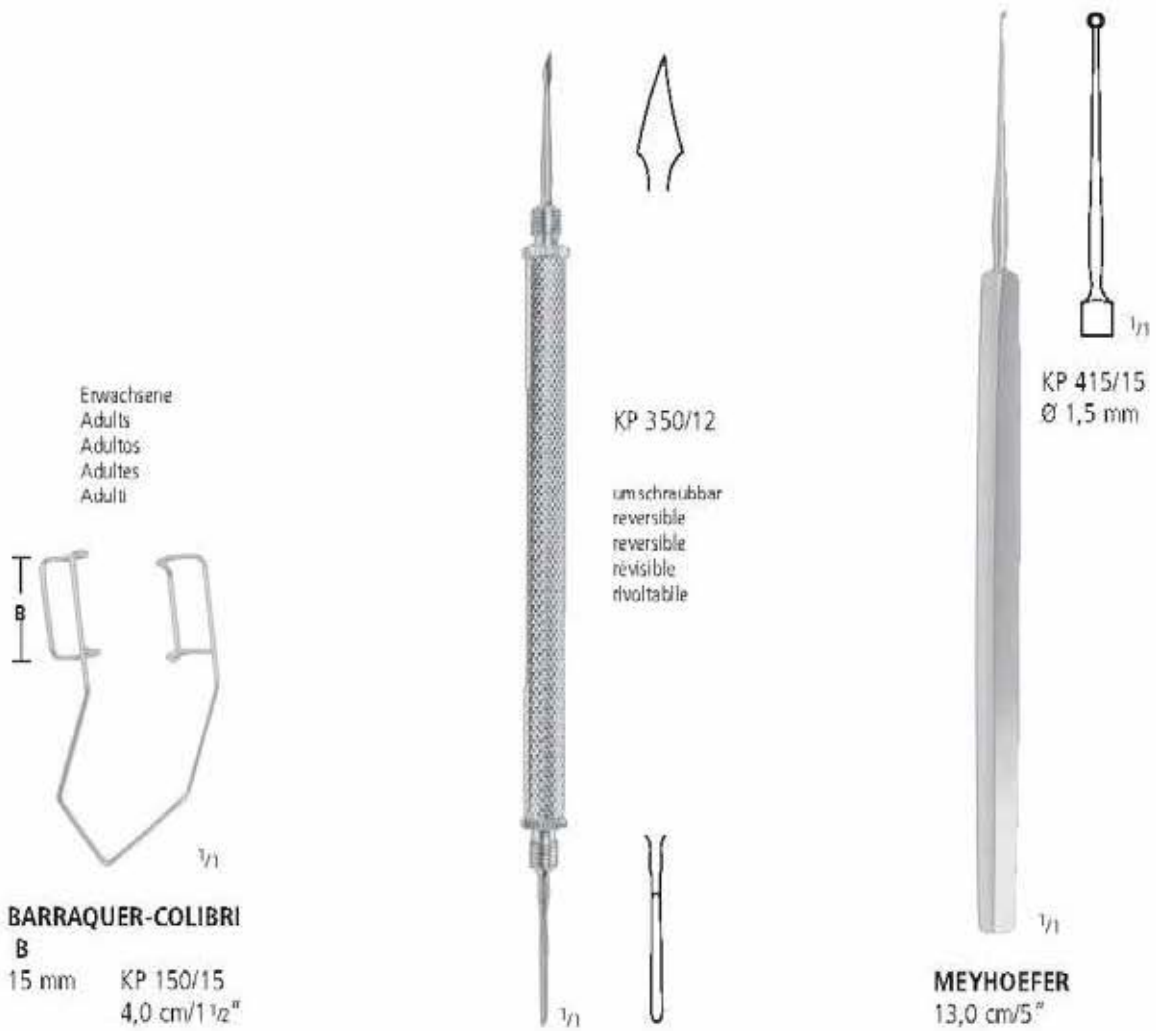

L(mm)	B(mm)	
275	125	SX 432/01

Contents:		Qty
AB 750/07	BARRAQUER-KATZIN FIX.FCPS 1X2 T. 7,0 CM	1
AC 779/01	GILLS-WELSH CAPSULOTOMY SCISSORS 8,5 CM	1
KP 150/15	BARRAQUER-COLIBRI EYE SPECULA 15 MM 4,0 CM	1
SX 432/01	SILICON MAT 275X125 MM	1

Sterilization container KYE 351/01, if required

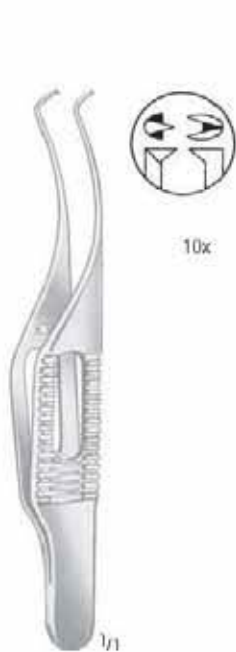

**BARRAQUER-KATZIN 1:2
(Colibri)**
AB 750/07
7,0 cm/2³/₄"



GILLS-WELSH
AC 779/01
8,5 cm/3¹/₂"



BARRAQUER-COLIBRI
B
15 mm KP 150/15
4,0 cm/1¹/₂"



L(mm)	B(mm)	
275	125	SX 432/01

Contents:		Qty
AA 060/03	DIEFFENBACH BULLDOG CLAMPS STR 3,5 CM	1
AA 114/10	HARTMANN FORCEPS STR 10,0 CM	1
AA 751/13	BACKHAUS TOWEL FORCEPS 13,0 CM	1
AB 734/01	BONN IRIS FORCEPS W.GUIDE PIN 1X2T. 7,0 CM	1
AB 816/01	CASTROVIEJO SUTURE FORCEPS 10,0 CM	2
AB 828/10	PAUFIQUE SUTURE FORCEPS 1X2 TEETH 10,0 CM	1
AB 835/09	BERENS MUSCLE CLAMP 8,5 CM 5 TEETH WITH	1
AC 450/10	IRIS SCISSORS STR SH/SH 10,5 CM	1
AC 475/11	STEVENS TENOTOM.SCS.CVD POINTED 11,5 CM	1
AC 780/11	WESTCOTT TENOTOMY SCS. POINTED 11,0 CM	1
AC 797/01	WESTCOTT STRABISMUS SCS STR SHARP 11,5 CM	1
AE 660/14	CASTROVIEJO NH STR RA SMOOTH 14,0 CM	1
AE 661/14	CASTROVIEJO NH CVD RA SMOOTH 14,0 CM	1
AR 282/20	CASTROVIEJO CIRCLE 8,0 CM STRAIGHT	1
KP 001/13	GREEN STRABISMUS HOOK 13,0 CM	1
KP 010/14	GASS RETINAL DETACHMENT HOOK 14,0 CM	1
KP 015/01	GRAEFE STRABISMUS HOOK #1 13,0 CM	1
KP 015/02	GRAEFE STRABISMUS HOOK #2 14,0 CM	1
KP 015/03	GRAEFE STRABISMUS HOOK #3 15,0 CM	1
KP 018/12	STEVENS TENOTOMY HOOK 12,0 CM	1
KP 175/09	CASTROVIEJO EYE SPECULA 16,0 MM 9,0 CM	1
KP 262/13	ARRUGA PROTECTOR 13,0 CM	1
KP 540/13	GONNIN AMSLER MARKER 11-23 MM / 1 MM	1
KP 700/00	BISHOP-HARMON ANTERIOR CHAMBER	1
SK 105/05	WIRE BASKET, 255 X 245 X 50 MM	1

Sterilization Container KYE 200/11, if required

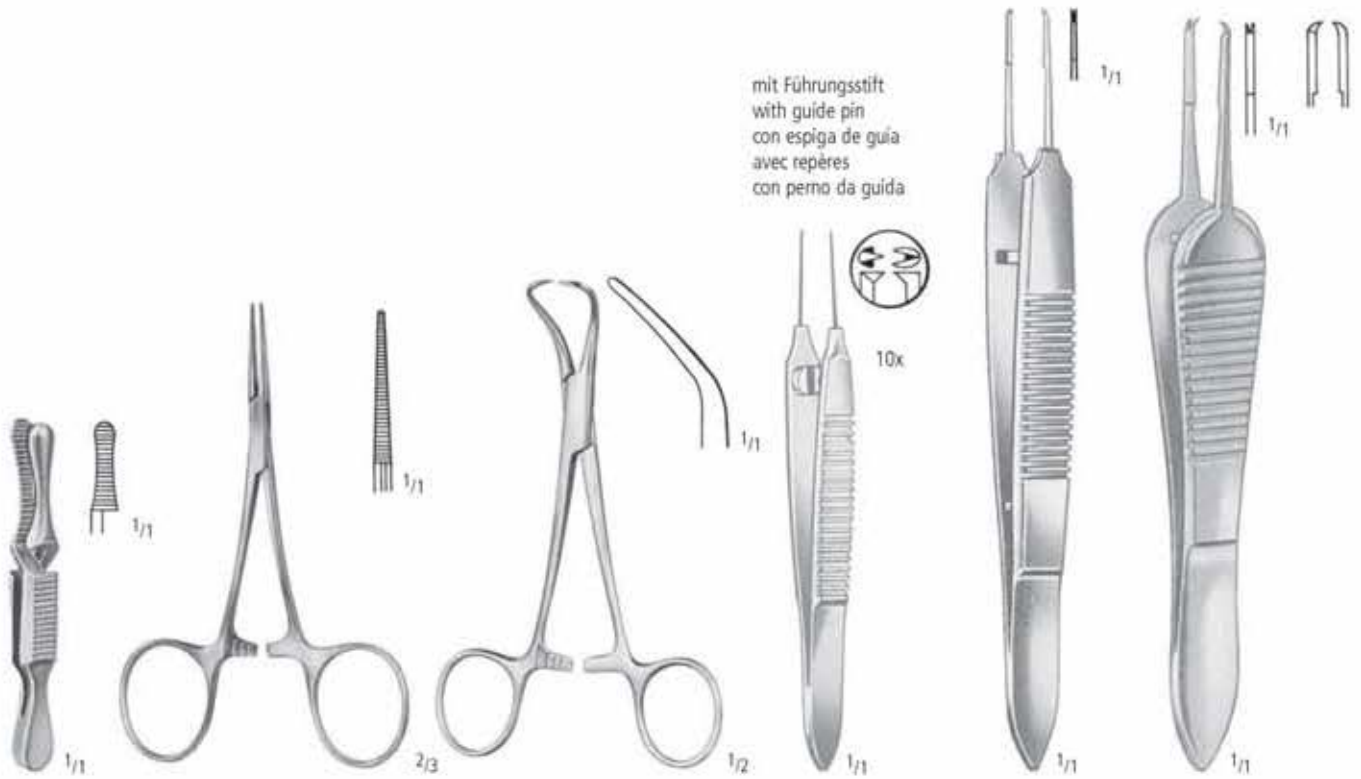

mit Führungsstift
with guide pin
con espiga de guía
avec repères
con perno da guida

DIEFFENBACH
AA 060/03
3,5 cm/1¹/₂"

HARTMANN
AA 114/10
10,0 cm/4"

BACKHAUS
AA 751/13
13,0 cm/5"

MOD. BONN 1:2
AB 734/01
7,0 cm/2³/₄"

CASTROVIEJO 1:2
AB 816/01
0,12 mm
10,0 cm/4"

PAUFIQUE 1:2
AB 828/10
10,0 cm/4"



BERENS
AB 835/09
8,5 cm/3¹/₃"

Irisscheren
Iris Scissors
Tijeras para iridectomía
Ciseaux à iridectomie
Forbici per iridectomia



AC 450/10
10,5 cm/4¹/₄"

Sehnenscheren
Tenotomy Scissors
Tijeras para tenotomía
Ciseaux à tenotomie
Forbici per tenotomia

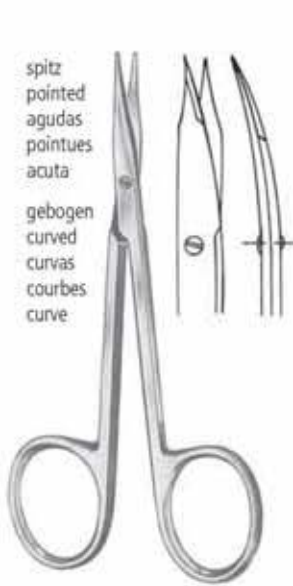

STEVENS
AC 475/11
11,5 cm/4¹/₂"

spitz
pointed
agudas
pointues
acuta
gebogen
curved
curvas
courbes
curve



WESTCOTT
AC 780/11
11,0 cm/4¹/₃"



WESTCOTT
AC 797/01
11,5 cm/4¹/₂"



CASTROVIEJO
14,0 cm/5¹/₂"

Messbereich 20 mm
measuring range 20 mm
campo de medición 20 mm
étendue de mesurage 20 mm
ampiezza di misura 20 mm



CASTROVIEJO
AR 282/20
8,0 cm/ 3"



GREEN
KP 001/13
13,0 cm/5"



GASS
KP 010/14
14,0 cm/5 1/2"



GRAEFE
KP 015/01
13,0 cm/5"
Fig. 1



GRAEFE
KP 015/02
14,0 cm/5 1/2"
Fig. 2



GRAEFE
KP 015/03
15,0 cm/6"
Fig. 3



STEVENS
KP 018/12
12,0 cm/4 3/4"



CASTROVIEJO
KP 175/09
9,0 cm/3 1/2"
B = 16 mm



ARRUGA
KP 262/13
13,0 cm/5"



GONNIN
KP 540/13
13,0 cm/5"
11-23 mm / 1 mm



BISHOP-HARMON
KP 700/00

Set komplett
Set complete
Juego completo
Jeu complet
Set completo



L(mm)	B(mm)	H(mm)	
255	245	50	SK 105/05

ZS 160/20 CHALAZION CHALAZION CHALAZIÓN CHALAZION CALAZIO

Contents:		Qty
AB 828/10	PAUFIQUE SUTURE FORCEPS 1X2 TEETH 10,0 CM	1
AB 840/01	DESMARRES CHALAZION FORCEPS FIG.1 9,0 CM	1
AB 840/02	DESMARRES CHALAZION FORCEPS FIG.2 9,0 CM	1
AC 467/10	IRIS SCISSORS CVD W LARGE BOWS 10,0 CM	1
AE 661/14	CASTROVIEJO NH CVD RA SMOOTH 14,0 CM	1
KP 248/11	JAEGER LID PLATE 11,0 CM	1
KP 415/10	MEYHOEFER CHALAZION CURETTE 13,0 CM	1
KP 415/20	MEYHOEFER CHALAZIONCURETTE 13,0 CM 2,0 MM	1
KP 415/25	MEYHOEFER CHALAZIONCURETTE 13,0 CM 2,5 MM	1
SK 105/05	WIRE BASKET, 255 X 245 X 50 MM	1

Sterilization Container KYE 200/11, if required



MOD. TÜBINGEN
AB 826/10
10,0 cm/4"



DESMARRES
9,0 cm/3 1/2"

mit großen Ringen
with large bows
con anillos grandes
avec grands anneaux
con anelli grandi



AC 467/10
10,0 cm/4"



CASTROVIEJO
AE 661/14
14,0 cm/5 1/2"



JAEGER
KP 248/11
11,0 cm/4 1/2"



MEYHOEFER
13,0 cm/5"

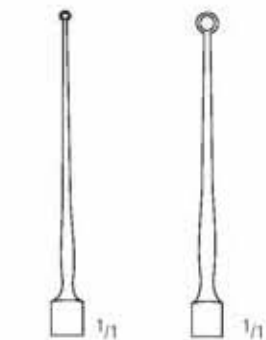

KP 415/10 Ø 1,0 mm
KP 415/20 Ø 2,0 mm



KP 415/25 Ø 2,5 mm



L(mm)	B(mm)	H(mm)	
255	245	50	SK 105/05

Contents:		Qty
AA 150/14	HALSTED-MOSQUITO ART.FCPS STR 14,0 CM	2
AA 151/14	HALSTED-MOSQUITO ART.FCPS CVD 14,0 CM	2
AA 751/08	BACKHAUS TOWEL FORCEPS 8,0 CM	2
AB 785/01	GRAEFE FIX.FCPS W/O SPRING CATCH 11,0 CM	1
AB 828/10	PAUFIQUE SUTURE FORCEPS 1X2 TEETH 10,0 CM	1
AB 832/01	BLASCOVICS MUSCULAR FORCEPS FIG.1 9,0 CM	1
AC 461/11	STRABISMUS SCISSORS CVD BLUNT 11,5 CM	1
AC 467/10	IRIS SCISSORS CVD W LARGE BOWS 10,0 CM	1
AC 475/11	STEVENS TENOTOM.SCS.CVD POINTED 11,5 CM	1
AE 661/14	CASTROVIEJO NH CVD RA SMOOTH 14,0 CM	1
KP 015/03	GRAEFE STRABISMUS HOOK FIG. 3 15,0 CM	1
KP 200/15	COOK EYE SPECULA 15 MM 5,0 CM	1
KP 400/01	BUNGE EXENTERATION SPOON 14,0 CM 7,0 MM	1
KP 405/15	WELLS ENUCLEATION SPOON LARGE 15,0 CM	1
SK 105/05	WIRE BASKET, 255 X 245 X 50 MM	1

Sterilization Container KYE 200/11, if required



ohne Schloss
without spring catch
sin cierre de resorte
sans arrêt à ressort
senza arresto a molla

HALSTED-MOSQUITO
AA 150/14 AA 151/14
14,0 cm/5 1/2"

BACKHAUS
AA 751/08
8,0 cm/3"

GRAEFE
AB 785/01
11,0 cm/4 1/3"

PAUFIQUE 1:2
AB 828/10
10,0 cm/4"

BLASCOVICS
AB 832/01
9,0 cm/3 1/2"

Strabismusscheren
Strabismus Scissors
Tijeras para estrabismos
Ciseaux à strabisme
Forbici per strabismo

mit großen Ringen
with large bows
con anillos grandes
avec grands anneaux
con anelli grandi

Sehnenscheren
Tenotomy Scissors
Tijeras para tenotomia
Ciseaux à ténonomie
Forbici per tenotomia



AC 460/11
11,5 cm/4 1/2"

AC 467/10
10,0 cm/4"

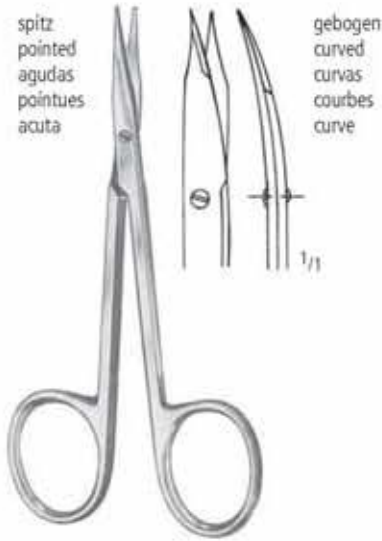

spitz
pointed
agudas
pointues
acuta

gebogen
curved
curvas
courbes
curve

STEVENS
AC 475/11
11,5 cm/4 1/2"



CASTROVIEJO
AE 661/14
14,0 cm/5 1/2"

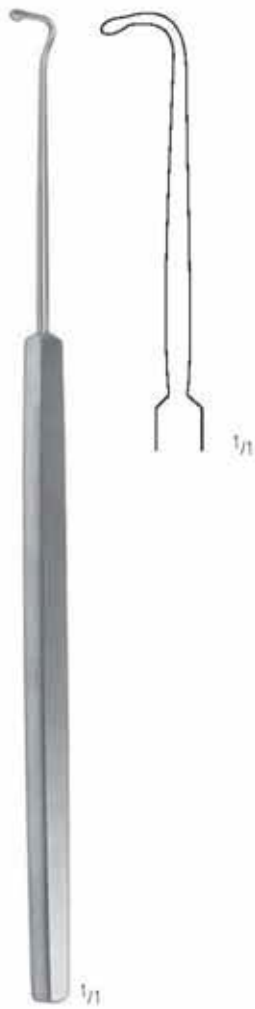

GRAEFE
 KP 015/03
 15,0 cm/6"
 Fig. 3



COOK
 B
 15 mm
 KP 200/15
 5,0 cm/ 2"



BUNGE
 KP 400/01
 14,0 cm/5 1/2"

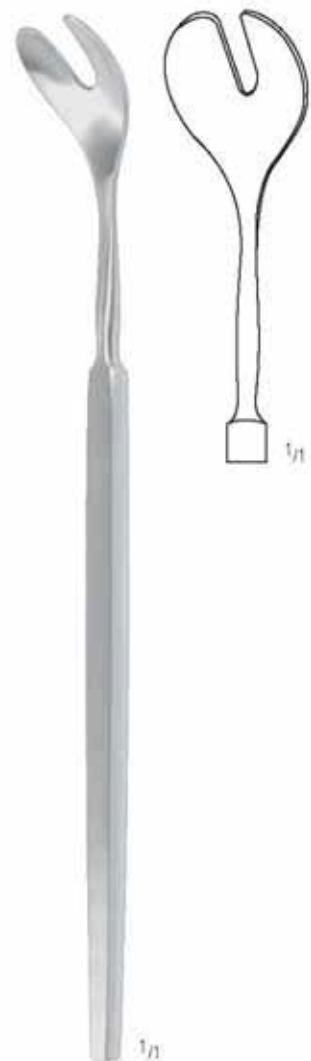

WELLS
 KP 405/15
 15,0 cm/6"



L(mm)	B(mm)	H(mm)	
255	245	50	SK 105/05

Contents:		Qty
AA 114/10	HARTMANN FORCEPS STR 10,0 CM	1
AA 751/08	BACKHAUS TOWEL FORCEPS 8,0 CM	2
AB 710/10	GRAEFE IRIS FORCEPS STR SERR. 10,0 CM	1
AB 714/10	GRAEFE IRIS FORCEPS STR 1X2 TEETH 10,0 CM	1
AB 734/01	BONN IRIS FORCEPS W.GUIDE PIN 1X2T. 7,0 CM	1
AB 750/07	BARRAQUER-KATZIN FIX.FCPS 1X2 T. 7,0 CM	1
AB 792/11	ELSCHNIG FIXATION FORCPES 1X2 TEETH 11,0 CM	1
AB 825/02	BONN SUTURE FORCEPS 10,0 CM ULTRA FINE	2
AC 431/08	MOD.BONN SCISSORS CVD 8,0 CM	1
AC 768/05	BARRAQUER EYE SCISSORS 5,50 CM 5,0 MM	1
AC 776/02	VANNAS MOD.TÜBINGEN CURVED 8,5 CM	1
AC 782/11	WESTCOTT TENOTOMY SCISSORS BLUNT 11,0 CM	1
AE 605/11	BARRAQUER MICRO-NEEDLE HOLDER CVD 10,0 CM	1
AE 660/14	CASTROVIEJO NH STR RA SMOOTH 14,0 CM	1
AR 282/20	CASTROVIEJO CIRCLE 8,0 CM STRAIGHT	1
KP 130/01	HARMS TRABECULAR PROBE RIGHT 4,5 CM	1
KP 130/02	HARMS TRABECULAR PROBE LEFT 4,5 CM	1
KP 161/05	CORCELLE EYE SPECULA 8 MM, 5,0 CM	1
KP 373/01	PREMIUM DIAMOND KNIFE ANGLED SPEER 1,4 CM	1
KP 376/01	PREMIUM DIAMOND KNIFE 1,0 CM 45° 7 STEPS	1
KP 478/12	MOD.DORTMUND PHACO SPATULA 12,0 CM	1
KP 543/01	SCHIOETZ TONOMETER INCLINED SCALE	1
KP 611/00	ELLIOT TREPHINE HANDLE ONLY 3,0 CM	1
KP 612/10	ELLIOT SCLERAL TREPHINE Ø 1,0 MM	1
KP 700/00	BISHOP-HARMON ANTERIOR CHAMBER	1
KP 712/27	MCINTYRE ANTERIOR CHAMBER CANNULA 27G	2
KP 731/27	SAUTTER AIR INJECTION CANNULA 27G 3,5 CM	2
SK 305/05	WIRE BASKET, 485 X 255 X 50 MM	1

Sterilization Container KYE 200/61, if required



HARTMANN
AA 114/10
10,0 cm/4"



BACKHAUS
AA 751/08
8,0 cm/3"



GRAEFE
10,0 cm/4"

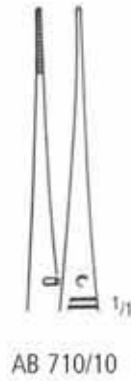

AB 710/10

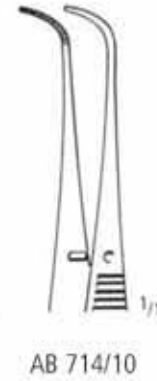

AB 714/10



MOD. BONN 1:2
AB 734/01
7,0 cm/2³/₄"



10x

mit Führungsstift
with guide pin
con espiga de guía
avec repères
con perno da guida



BARRAQUER-KATZIN 1:2 (Colibri)
AB 750/07
7,0 cm/2³/₄"



ELSCHNIG 1:2
AB 792/11
11,0 cm/4¹/₃"



MOD. BONN
AB 825/02
10,0 cm/4"



10 x
0,12 mm

sehr fein
extra delicate
muy finas
très fin
molto sottile

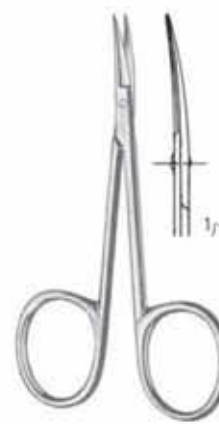

MOD. BONN
AC 431/08
8,0 cm/3"



BARRAQUER
5 mm AC 768/05
5,5 cm/2¹/₄"



gebogen
curved
curvas
courbes
curve

VANNAS MOD. TÜBINGEN
AC 776/02
8,5 cm/3¹/₃"



WESTCOTT
AC 782/11
11,0 cm/4¹/₃"



BARRAQUER
AE 605/13
13,0 cm/5"



CASTROVIEJO
AE 660/14
14,0 cm/5¹/₂"

Messbereich 15 mm
measuring range 15 mm
campo de medición 15 mm
étendue de mesurage 15 mm
ampiezza di misura 15 mm



CASTROVIEJO
AR 282/15
8,0 cm/ 3"

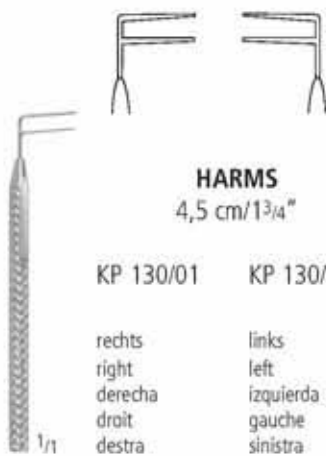

HARMS
4,5 cm/1³/₄"

KP 130/01 KP 130/02

rechts
right
derecha
droit
destra

links
left
izquierda
gauche
sinistra



CORCELLE
KP 161/05
5,0 cm/ 2"
B = 8 mm

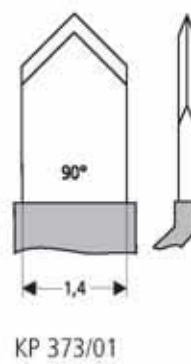

KP 373/01



1/1

7 Stufen:
7 steps:
7 escalones:
7 étages:
7 gradi:
0 / 0,3 / 0,4 / 0,5 / 0,6 / 0,8 / 1,0 / 2,5 mm

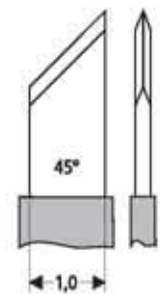

KP 376/01



1/1



MOD. DORTMUND
 KP 478/12
 12,0 cm/ 4³/₄"
 0,6 x 12 mm



schräge Skala
 inclined scale
 graduado inclinado
 échelle oblique
 scala inclinata

SCHIOETZ
 KP 543/01
 13,0 cm/5"

Spezifikation Nr. 5, geeicht
 Specification No. 5, calibrated
 Especificación No. 5, calibrada
 Specification No. 5, calibrée
 Specifica No. 5, calibrata



ELLIOT
 KP 611/00
 3,0 cm/1¹/₄"



ELLIOT
 KP 612/10
 Ø 1,0 mm

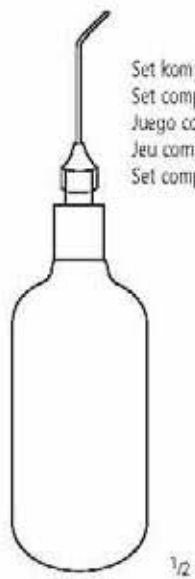

BISHOP-HARMON
 KP 700/00

Set komplett
 Set complete
 Juego completo
 Jeu complet
 Set completo



McINTYRE
 2,5 cm/1"
 KP 712/27
 27G

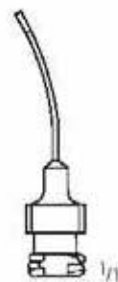

SAUTTER
 KP 731/27
 3,5 cm/1¹/₂"
 27G



L(mm)	B(mm)	H(mm)	
485	255	50	SK 305/05

Contents:		Qty
AA 060/05	DIEFFENBACH BULLDOG CLAMPS STR 5,0 CM	2
AA 114/10	HARTMANN FORCEPS STR 10,0 CM	1
AA 751/08	BACKHAUS TOWEL FORCEPS 8,0 CM	2
AB 714/10	GRAEFE IRIS FORCEPS STR 1X2 TEETH 10,0 CM	1
AB 735/02	BONN MICRO IRIS FORCEPS ANGLED 7,0 CM	1
AB 750/07	BARRAQUER-KATZIN FIX.FCPS 1X2 T. 7,0 CM	1
AB 768/01	ARRUGA CAPSULAR FCPS NOT CALIBR. 10,0 CM	1
AB 792/11	ELSCHNIG FIXATION FORCPES 1X2 TEETH 11,0 CM	1
AB 819/02	MCPHERSON TYING FORCEPS ANGLED 10,5 CM	1
AB 825/02	BONN SUTURE FORCEPS 10,0 CM ULTRA FINE	1
AB 848/11	FAULKNER LENS HOLDING FORCEPS 11,0 CM	1
AC 431/08	MOD.BONN SCISSORS CVD 8,0 CM	1
AC 768/10	BARRAQUER EYE SCISSORS 5,5 CM 10 MM	1
AC 776/03	VANNAS MOD.TÜBINGEN ANGLED 8,5 CM	1
AC 778/02	VANNAS SEC.CATARACT SCISSORS,CVD. 8,0 CM	1
AC 782/11	WESTCOTT TENOTOMY SCISSORS BLUNT 11,0 CM	1
AC 785/01	CASTROVIEJO DELICATE EYE SCS. 10,0 CM RI.	1
AC 785/02	CASTROVIEJO DELICATE EYE SCS. 10,0 CM LE.	1
AC 797/02	WESTCOTT STRABISMUS SCS CVD SHARP 11,5 CM	1
AD 075/11	PCK=100 BLADES FIG.11	1
AD 554/13	BLADE BREAKER 13.0 CM DIA 8,0 MM	1
AE 603/10	BARRAQUER-TROUTMAN MICRO-NH CVD 10,0 CM	1
AE 660/14	CASTROVIEJO NH STR RA SMOOTH 14,0 CM	1
AE 688/14	KALT MICRO-NEEDLE HOLDER STR 14,0 CM	1
AR 282/20	CASTROVIEJO CIRCLE 8,0 CM STRAIGHT	1
KP 030/13	HIRSCHMANN IRIS HOOK 12,5 CM 45°	1
KP 071/25	SINSKEY LENS MANIPULATOR 12,0 CM	1
KP 154/04	BARRAQUER PHACO EYE SPECULA 4,0 CM	1
KP 440/13	SNELLEN LENS SCOOP SERRATED 13,0 CM	1
KP 478/12	MOD.DORTMUND PHACO SPATULA 12,0 CM	1
KP 545/02	MALONEY KERATOMETER INTRAOPERATIVE 2,0 CM	1
KP 700/00	BISHOP-HARMON ANTERIOR CHAMBER	1
KP 712/27	MCINTYRE ANTERIOR CHAMBER CANNULA 27G	1
KP 720/23	SIMCOE IRRIGATION AND ASPIRATION CANNULA	1
KP 731/27	SAUTTER AIR INJECTION CANNULA 27G 3,5 C	2
KP 755/23	KNOLLE-PEARCE LENS LOOP WITH IRRIGATION	1
KP 767/27	JENSEN CAPSULE POLISHER 27G DIAMOND	1
SK 305/05	WIRE BASKET, 485 X 255 X 50 MM	1

Sterilization Container KYE 200/61, if required



DIEFFENBACH
AA 060/05
5,0 cm/2"



HARTMANN
AA 114/10
10,0 cm/4"



BACKHAUS
AA 751/08
8,0 cm/3"

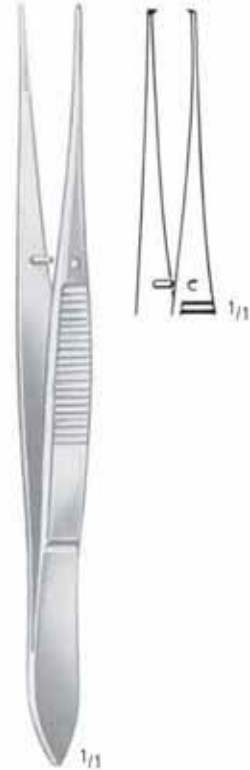

GRAEFE
AB 714/10
10,0 cm/4"



MOD. BONN
AB 735/02
7,0 cm/2³/₄"



BARRAQUER-KATZIN 1:2 (Colibri)
AB 750/07
7,0 cm/2³/₄"



ungeeicht
not calibrated
non calibrada
non calibrée
non calibrata

ARRUGA
AB 768/01
10,0 cm/4"



ELSCHNIG 1:2
AB 792/11
11,0 cm/4¹/₃"



McPHERSON
AB 819/02
10,0 cm/4"

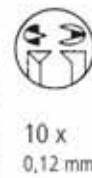

10 x
0,12 mm

MOD. BONN
AB 825/02
10,0 cm/4"



FAULKNER
AB 848/11
11,0 cm/4¹/₃"

sehr fein
extra delicate
muy finas
très fin
molto sottile

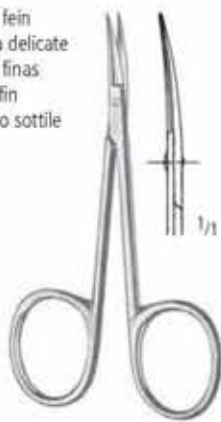

MOD. BONN
AC 431/08
8,0 cm/3"



BARRAQUER
5,5 cm/2¹/₄"
10 mm AC 768/10



kniegebogen
angular
acodadas
coudés
angolato

VANNAS MOD. TÜBINGEN
AC 776/03
8,5 cm/3¹/₃"

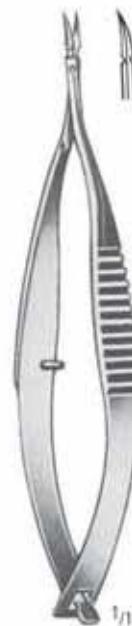

gebogen
curved
curvas
courbes
curve

VANNAS
AC 778/02
8,0 cm/3"



WESTCOTT
AC 782/11
11,0 cm/4¹/₃"



CASTROVIEJO
AC 785/01
10,0 cm/4"



CASTROVIEJO
AC 785/02
10,0 cm/4"

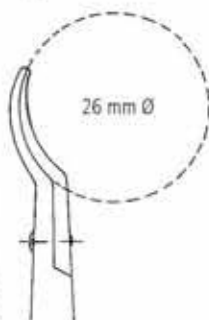

WESTCOTT
AC 797/02
11,5 cm/4¹/₂"



Fig.11
AD 075/11

steril
sterile
estériles
stériles
sterili



CASTROVIEJO
AD 554/13
Ø 8 mm
13,0 cm/5"

Messbereich 20 mm
measuring range 20 mm
campo de medición 20 mm
étendue de mesurage 20 mm
ampiezza di misura 20 mm



**BARRAQUER-
TROUTMAN**
AE 603/10
10,0 cm/4"



CASTROVIEJO
AE 660/14
14,0 cm/5 1/2"



KALT
AE 688/14
14,0 cm/5 1/2"



CASTROVIEJO
AR 282/20
8,0 cm/ 3"



HIRSCHMANN
KP 030/13
12,5 cm/5"



SINSKEY
KP 071/25
Ø 0,25 mm
12,0 cm/4 3/4"

TITANIUM



BARRAQUER PHAKO
KP 154/04
4,0 cm/1 1/2"



SNELLEN
KP 440/13
13,0 cm/5"



MOD. DORTMUND
KP 478/12
12,0 cm/ 4 3/4"
0,6 x 12 mm



MALONEY
KP 545/02
2,0 cm/3/8"

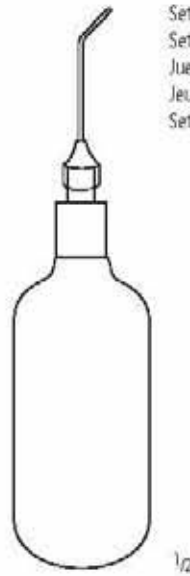

BISHOP-HARMON
KP 700/00

Set komplett
Set complete
Juego completo
Jeu complet
Set completo



McINTYRE
2,5 cm/1"
KP 712/27
27G



SIMCOE
KP 720/23
3,0 cm/1 1/4"
25/23G

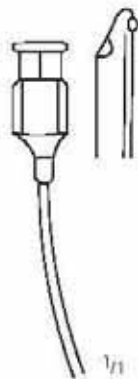

SAUTTER
KP 731/27
3,5 cm/1 1/2"
27G

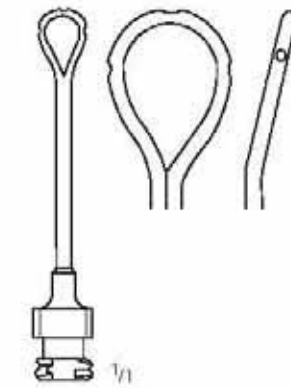

KNOLLE-PEARCE
KP 755/23
5,0 cm/2"
23G

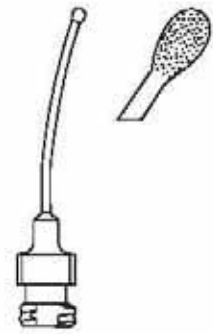

JENSEN
KP 767/27
4,5 cm/2"
27G



L(mm)	B(mm)	H(mm)	
485	255	50	SK 305/05

Contents:		Qty
AA 060/05	DIEFFENBACH BULLDOG CLAMPS STR 5,0 CM	2
AA 150/14	HALSTED-MOSQUITO ART.FCPS STR 14,0 CM	1
AA 751/15	BACKHAUS TOWEL FORCEPS 15,0 CM	2
AB 714/10	GRAEFE IRIS FORCEPS STR 1X2 TEETH 10,0 CM	1
AB 750/07	BARRAQUER-KATZIN FIX.FCPS 1X2 T. 7,0 CM	1
AB 767/02	CASTROVIEJO CAPSULAR FCPS CROSSED 10,0 CM	1
AB 768/01	ARRUGA CAPSULAR FCPS NOT CALIBR. 10,0 CM	1
AB 792/11	ELSCHNIG FIXATION FORCPES 1X2 TEETH 11,0 CM	1
AB 819/02	MCPHERSON TYING FORCEPS ANGLED 10,5 CM	1
AB 825/02	BONN SUTURE FORCEPS 10,0 CM ULTRA FINE	1
AB 848/11	FAULKNER LENS HOLDING FORCEPS 11,0 CM	2
AB 852/02	MCDONALD IOL CAPSULORHEXIS FORCEPS 10,0 CM	1
AC 431/08	MOD.BONN SCISSORS CVD 8,0 CM	1
AC 776/04	VANNAS MOD.TÜBINGEN ANGLED O.FL. 8,5 CM	1
AC 778/03	VANNAS SEC.CATARACT SCISSORS,ANGULAR, 8,0 CM	1
AC 782/11	WESTCOTT TENOTOMY SCISSORS BLUNT 11,0 CM	1
AD 075/11	PCK=100 BLADES FIG.11	1
AD 550/09	BLADE BREAKER 9.0 CM DIA 5,5 MM	1
AD 551/09	BLADE BREAKER CVD 9.0 CM DIA 5,5 MM	1
AE 605/14	BARRAQUER MICRO-NEEDLE HOLDER CVD 14,0 CM	1
AE 660/14	CASTROVIEJO NH STR RA SMOOTH 14,0 CM	1
AE 688/14	KALT MICRO-NEEDLE HOLDER STR 14,0 CM	1
AR 282/20	CASTROVIEJO CIRCLE 8,0 CM STRAIGHT	1
KP 030/13	HIRSCHMANN IRIS HOOK 12,5 CM 45°	1
KP 040/02	JAFFE-BECHERT LENS NUCLEUS ROTATOR 12,0 CM	1
KP 067/60	NAGAHARA PHACO SPLITTER 12,0 CM 60°	1
KP 071/25	SINSKEY LENS MANIPULATOR 12,0 CM	1
KP 154/04	BARRAQUER PHACO EYE SPECULA 4,0 CM	1
KP 210/02	LIEBERMAN EYE SPECULA 15 MM K-SHAPE 8,0 CM	1
KP 335/12	MOD. HAMBURG KERATOME 12,0 CM	1
KP 370/04	PREMIUM DIAMOND KNIFE ANGLED LANCE 1,4 CM	1
KP 371/01	PREMIUM DIAMOND KNIFE STR.TRI-FACET 1,0 CM	1
KP 371/02	PREMIUM DIAMOND KNIFE ANGLED 2,0 CM	1
KP 545/02	MALONEY KERATOMETER INTRAOPERATIVE 2,0 CM	1
KP 550/12	THORNTON FIXATION RING FG-HINGE Ø13,0 MM	1
KP 700/00	BISHOP-HARMON ANTERIOR CHAMBER	1
KP 712/27	MCINTYRE ANTERIOR CHAMBER CANNULA 27G	1
KP 731/27	SAUTTER AIR INJECTION CANNULA 27G 3,5 CM	1
KP 767/27	JENSEN CAPSULE POLISHER 27G DIAMOND	2
SK 305/05	WIRE BASKET, 485 X 255 X 50 MM	1

Sterilization Container KYE 200/61, if required



DIEFFENBACH
AA 060/05
5,0 cm/2"

HALSTED-MOSQUITO
AA 150/14
14,0 cm/5 1/2"

BACKHAUS
AA 751/15
15,0 cm/6"

GRAEFE
AB 714/10
10,0 cm/4"

BARRAQUER-KATZIN 1:2 (Colibri)
AB 750/07
7,0 cm/2 3/4"

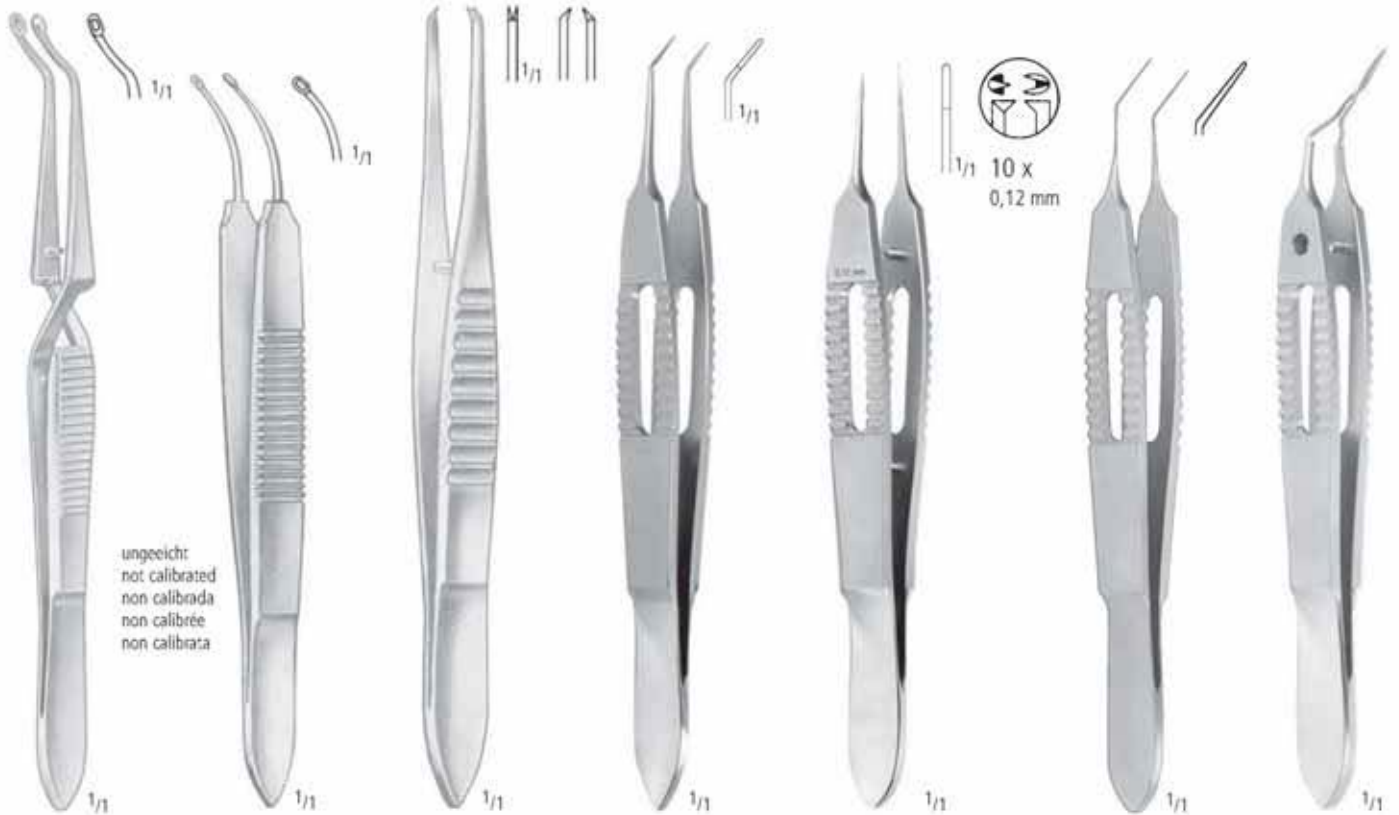

ungeeicht:
not calibrated
non calibrada
non calibrée
non calibrata

CASTROVIEJO
AB 767/02
10,0 cm/4"

ARRUGA
AB 768/01
10,0 cm/4"

ELSCHMIG 1:2
AB 792/11
11,0 cm/4 1/3"

McPHERSON
AB 819/02
10,0 cm/4"

MOD. BONN
AB 825/02
10,0 cm/4"

FAULKNER
AB 848/11
11,0 cm/4 1/3"

McDONALD
AB 852/02
10,0 cm/4"

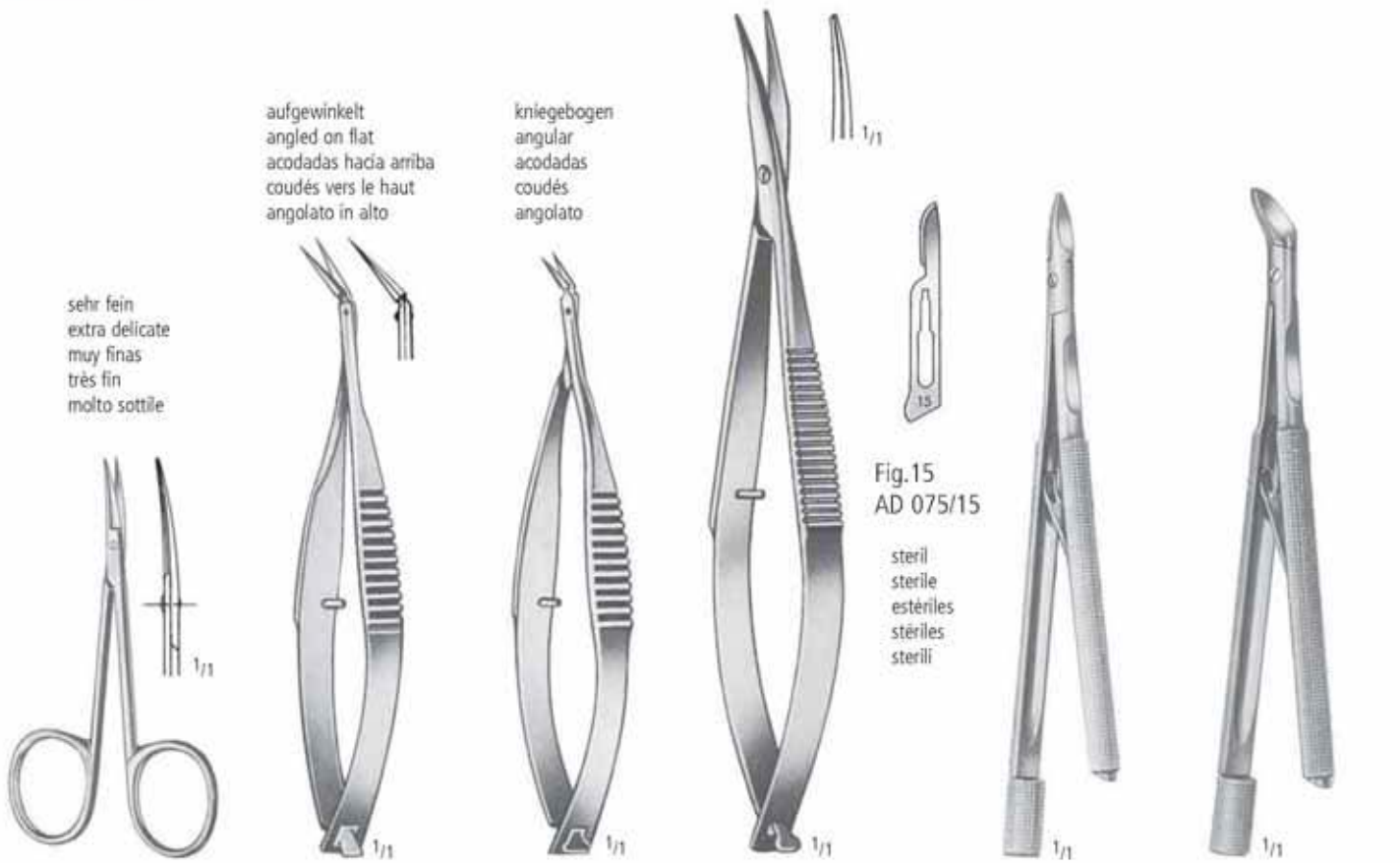

MOD. BONN
AC 431/08
8,0 cm/3"

VANNAS MOD. TÜBINGEN
AC 776/04
8,5 cm/3¹/₃"

VANNAS
AC 778/03
8,0 cm/3"

WESTCOTT
AC 782/11
11,0 cm/4¹/₃"

TROUTMAN-CHRIS
AD 550/09
Ø 5,5 mm
9,0 cm/3¹/₂"

TROUTMAN-CHRIS
AD 551/09
Ø 5,5 mm
9,0 cm/3¹/₂"

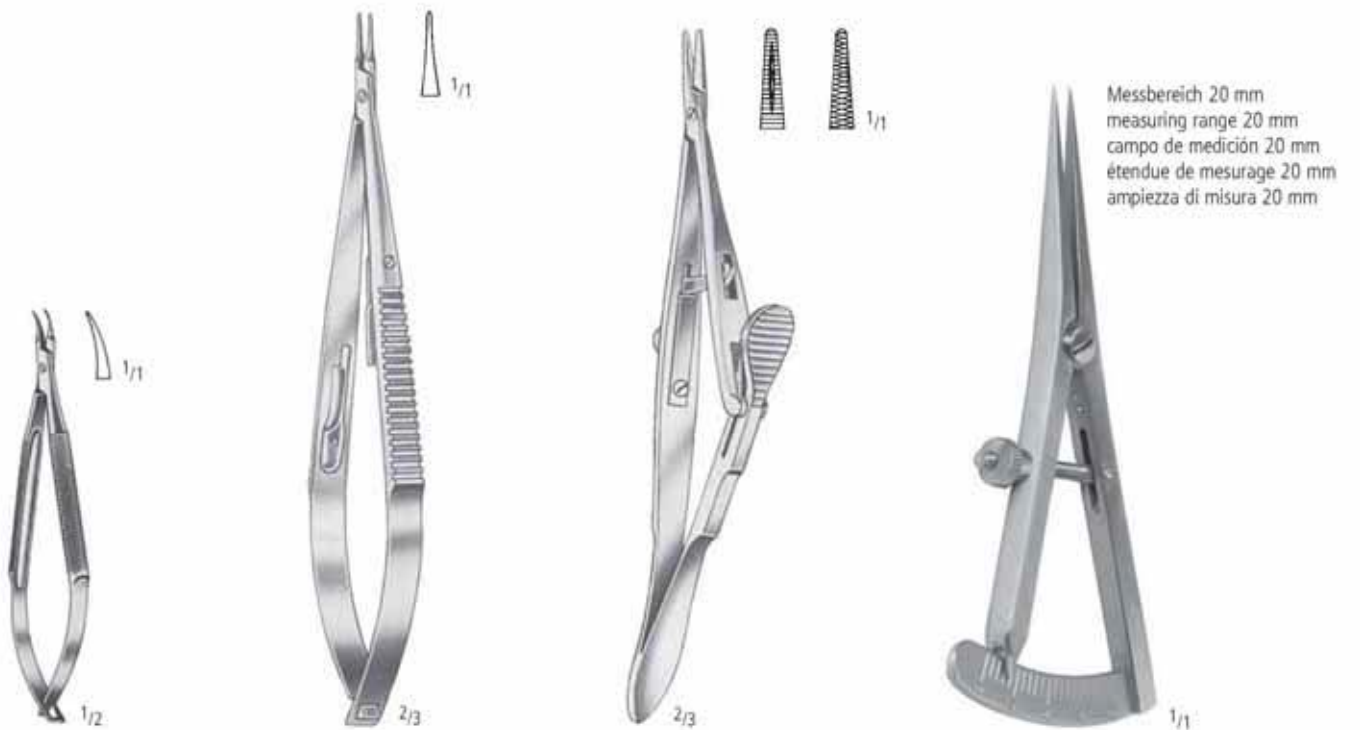

BARRAQUER
AE 605/11
11,0 cm/4¹/₃"

CASTROVIEJO
AE 660/14
14,0 cm/5¹/₂"

KALT
AE 688/14
14,0 cm/5¹/₂"

CASTROVIEJO
AR 282/20
8,0 cm/ 3"



HIRSCHMANN
KP 030/13
12,5 cm/5"



JAFFE-BECHERT
KP 040/02
12,0 cm/4 3/4"
L = 9 mm



NAGAHARA
KP 067/60
12,0 cm/4 3/4"
60°

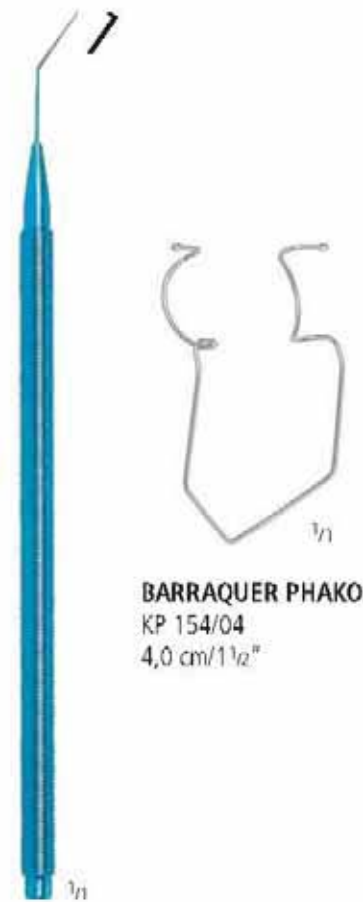

SINSKEY
KP 071/25
12,0 cm/4 3/4"
Ø 0,25 mm

TITANIUM

TITANIUM



BARRAQUER PHAKO
KP 154/04
4,0 cm/1 1/2"



LIEBERMAN
KP 210/02
8,0 cm/3 1/4"
B = 15 mm

K-förmig
K-shaped
forma K
forme K
forme K



MOD. HAMBURG
KP 335/12
12,0 cm/ 4 3/4"

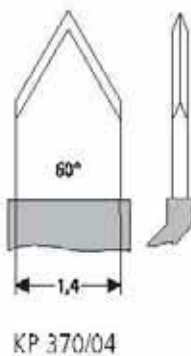

KP 370/04

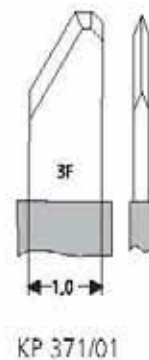

KP 371/01

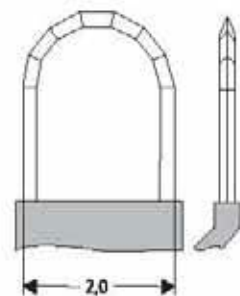

KP 371/02



MALONEY
 KP 545/02
 2,0 cm/3/4"

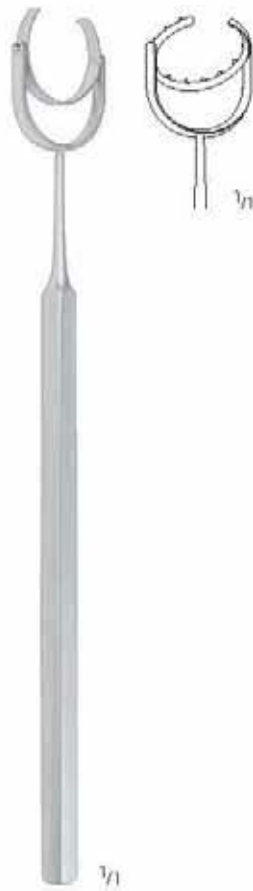

THORNTON
 KP 550/12
 12,0 cm/4 3/4"
 Ø 13 mm



BISHOP-HARMON
 KP 700/00



SAUTTER
 KP 731/27
 3,5 cm/1 1/2"
 27G

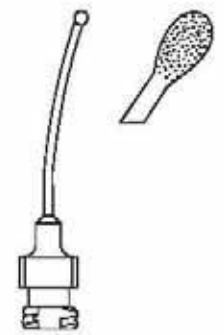

JENSEN
 KP 767/27
 4,5 cm/2"
 27G

Set komplett
 Set complete
 Juego completo
 Jeu complet
 Set completo

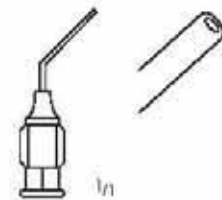

McINTYRE
 2,5 cm/1"
 KP 712/27
 27G



L(mm)	B(mm)	H(mm)	
485	255	50	SK 305/05

Contents:		Qty
AA 150/14	HALSTED-MOSQUITO ART.FCPS STR 14,0 CM	1
AA 751/15	BACKHAUS TOWEL FORCEPS 15,0 CM	2
AB 714/10	GRAEFE IRIS FORCEPS STR 1X2 TEETH 10,0 CM	1
AB 750/07	BARRAQUER-KATZIN FIX.FCPS 1X2 T. 7,0 CM	1
AB 792/11	ELSCHNIG FIXATION FORCPES 1X2 TEETH 11,0 CM	1
AB 816/10	CASTROVIEJO SUTURE FORCEPS 1.0MM 10,0 CM	1
AB 825/02	BONN SUTURE FORCEPS 10,0 CM ULTRA FINE	2
AC 431/08	MOD.BONN SCISSORS CVD 8,0 CM	1
AC 778/01	VANNAS SEC.CATARACT SCISSORS,STR. 8,0 CM	1
AC 782/11	WESTCOTT TENOTOMY SCISSORS BLUNT 11,0 CM	1
AC 785/01	CASTROVIEJO DELICATE EYE SCS.10,0 CM RIGHT	1
AC 791/01	KATZIN MICRO SCISSORS LEFT 11,0 CM	1
AC 791/02	KATZIN MICRO SCISSORS RIGHT 11,0 CM	1
AE 605/14	BARRAQUER MICRO-NEEDLE HOLDER CVD 14,0 CM	1
AE 660/14	CASTROVIEJO NH STR RA SMOOTH 14,0 CM	1
AE 688/14	KALT MICRO-NEEDLE HOLDER STR 14,0 CM	1
KP 150/15	BARRAQUER-COLIBRI EYE SPECULA 15 MM 4,0 CM	1
KP 325/05	BONN SCLERA KNIFE 5MM 12,5 CM	1
KP 370/02	PREMIUM DIAMOND KNIFE STR. 1,0 CM 45°	1
KP 508/10	BORES AXIS MARKER 10,0 CM	1
KP 535/12	ANIS SUTURE PLACEMENT MARKER 8 BLADES	1
KP 545/02	MALONEY KERATOMETER INTRAOPERATIVE 2,0 CM	1
KP 603/70	FRANCESCHETTI CERATOPLASTY TREPHINE	1
KP 603/80	FRANCESCHETTI CERATOPLASTY TREPHINE	1
KP 640/14	FLIERINGA SCLERAL FIXATION RING Ø 14,0 MM	1
KP 640/16	FLIERINGA SCLERAL FIXATION RING Ø 16,0 MM	1
KP 640/18	FLIERINGA SCLERAL FIXATION RING Ø 18,0 MM	1
KP 640/20	FLIERINGA SCLERAL FIXATION RING Ø 20,0 MM	1
KP 700/00	BISHOP-HARMON ANTERIOR CHAMBER	1
KP 731/27	SAUTTER AIR INJECTION CANNULA 27G 3,5 CM	2
SK 305/05	WIRE BASKET, 485 X 255 X 50 MM	1

Sterilization Container KYE 200/61, if required



HALSTED-MOSQUITO
AA 150/14
14,0 cm/5 1/2"



BACKHAUS
AA 751/15
15,0 cm/6"

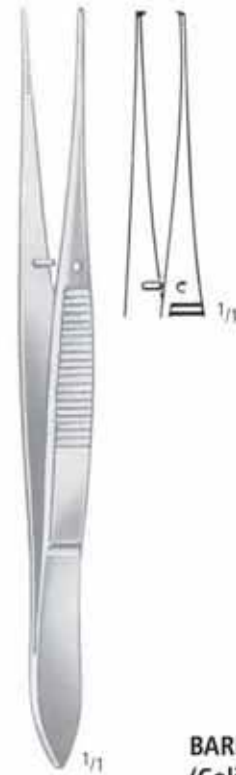

GRAEFE
AB 714/10
10,0 cm/4"



BARRAQUER-KATZIN 1:2 (Colibri)
AB 750/07
7,0 cm/2 3/4"



ELSCHMIG 1:2
AB 792/11
11,0 cm/4 1/3"



CASTROVIEJO 1:2
AB 816/10
1,00 mm
10,0 cm/4"



MOD. BONN
AB 825/02
10,0 cm/4"

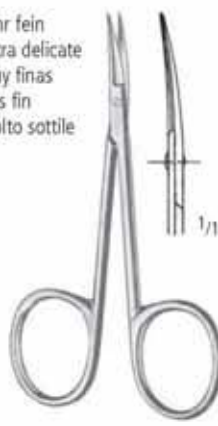

MOD. BONN
AC 431/08
8,0 cm/3"

sehr fein
extra delicate
muy finas
très fin
molto sottile



VANNAS
AC 778/01
8,0 cm/3"

gerade
straight
rectas
droits
rette



WESTCOTT
AC 782/11
11,0 cm/4 1/3"



CASTROVIEJO
AC 785/01
10,0 cm/4"



KATZIN
AC 791/01
11,0 cm/4¹/₃"



KATZIN
AC 791/02
11,0 cm/4¹/₃"



BARRAQUER
AE 605/11
11,0 cm/4¹/₃"



CASTROVIEJO
AE 660/14
14,0 cm/5¹/₂"



KALT
AE 688/14
14,0 cm/5¹/₂"



BARRAQUER-COLIBRI
B
15 mm KP 150/15
4,0 cm/1¹/₂"



BONN

KP 325/05
12,5 cm/ 5"
5 mm



KP 370/02

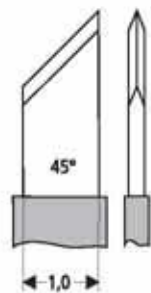

BORES
KP 508/10
10,0 cm/4"



ANIS
KP 535/12
12,0 cm/4³/₄"



MALONEY
KP 545/02
2,0 cm/3¹/₄"



mm Ø
7,0 KP 603/70
8,0 KP 603/80
FRANCESCETTI
7,5 cm/3"

Set komplett
Set complete
Juego completo
Jeu complet
Set completo



1/1

FLIERINGA

mm Ø

14	KP 640/14
16	KP 640/16
18	KP 640/18
20	KP 640/20

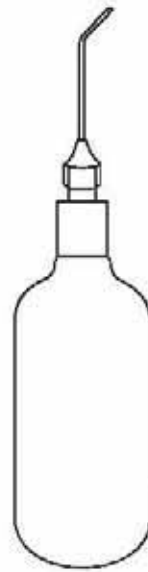

1/2

BISHOP-HARMON
KP 700/00



1/1

SAUTER
KP 731/27
3,5 cm/1 1/2"
27G



L(mm) B(mm) H(mm)

485 255 50 SK 305/05

Contents:		Qty
AB 750/07	BARRAQUER-KATZIN FIX.FCPS 1X2 T. 7,0 CM	1
KP 154/04	BARRAQUER PHACO EYE SPECULA 4,0 CM	1
KP 375/01	PREMIUM DIAMOND KNIFE 1,0 CM 15°	1
KP 500/70	HOFFER OPTICAL ZONE MARKER 7,0 MM 10,0 CM	1
KP 500/80	HOFFER OPTICAL ZONE MARKER 8,0 MM 10,0 CM	1
KP 508/10	BORES AXIS MARKER 10,0 CM	1
KP 515/12	LINDSTROM CORNEAL OPTICAL ZONE MARKER	1
KP 547/11	MENDEZ MEASURING INSTRUMENT DEGREE 10°C	1
KP 550/12	THORNTON FIXATION RING FG-HINGE Ø 13,0 MM	1
KP 741/23	LACRIMAL CANNULA 23G 4,0 CM CURVED	2
SK 105/05	WIRE BASKET, 255 X 245 X 50 MM	1

Sterilization Container KYE 200/11, if required



**BARRAQUER-KATZIN 1:2
(Colibri)**
AB 750/07
7,0 cm/2³/₄"



BARRAQUER PHAKO
KP 154/04
4,0 cm/1¹/₂"

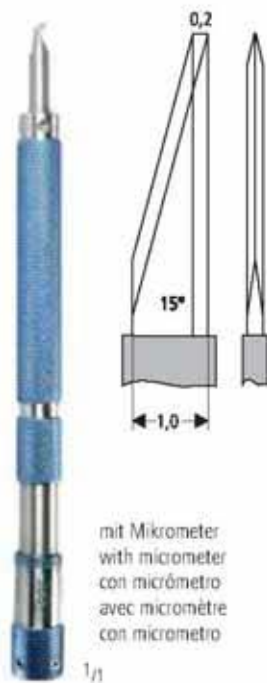

KP 375/01

mit Mikrometer
with micrometer
con micrómetro
avec micromètre
con micrometro



HOFFER
10,0 cm/4"
Ø 7,00 mm
Ø 8,00 mm



BORES
KP 508/10
10,0 cm/4"

KP 500/70
KP 500/80



LINDSTROM
KP 515/12
12,0 cm/4³/₄"
7 mm



MENDEZ
KP 547/11
11,0 cm/4¹/₂"
C 10°, 0 -180°



THORNTON
KP 550/12
12,0 cm/4³/₄"
Ø 13 mm



KP 741/23
3,5 cm/1¹/₂"
23G



L(mm)	B(mm)	H(mm)	
255	245	50	SK 105/05

Contents:		Qty
AA 060/06	DIEFFENBACH BULLDOG CLAMPS STR 6,0 CM	2
AA 151/12	HALSTED-MOSQUITO FCPS CVD 12,5 CM	1
AA 751/08	BACKHAUS TOWEL FORCEPS 8,0 CM	2
AB 710/07	GRAEFE IRIS FORCEPS STR SERR. 7,0 CM	1
AB 714/07	GRAEFE IRIS FORCEPS STR 1X2 TEETH 700 CM	1
AB 750/07	BARRAQUER-KATZIN FIX.FCPS 1X2 T. 7,0 CM	1
AB 792/11	ELSCHNIG FIXATION FORCPES 1X2 TEETH 11,0 CM	1
AB 816/01	CASTROVIEJO SUTURE FORCEPS 0,12 MM 10,0CM	1
AB 825/02	BONN SUTURE FORCEPS 10,0 CM ULRTA FINE	1
AB 825/02	BONN SUTURE FORCEPS 10,0 CM ULRTA FINE	1
AB 828/10	PAUFIQUE SUTURE FORCEPS 1X2 TEETH 10,0 CM	1
AB 833/01	JAMESON MUSCULAR FORCEPS 10,0 CM RIGHT	1
AB 833/02	JAMESON MUSCULAR FORCEPS 10,0 CM LEFT	1
AC 461/11	STRABISMUS SCISSORS CVD BLUNT 11,5 CM	1
AC 466/10	IRIS SCISSORS STR W LARGE BOWS 10,0 CM	1
AC 768/05	BARRAQUER EYE SCISSORS 5,5 CM 5,0 MM	1
AC 780/11	WESTCOTT TENOTOMY SCS.POINTEED 11,0 CM	1
AC 782/11	WESTCOTT TENOTOMY SCISSORS BLUNT 11,0 CM	1
AD 075/11	PCK=100 BLADES FIG. 11	1
AD 550/09	BLADE BREAKER 9.0 CM DIA 5,5 MM	1
AE 605/14	BARRAQUER MICRO-NEEDLE HOLDER CVD 14,0 CM	1
AE 607/14	BARRAQUER MICRO-NH CVD RA 14,0 CM	1
AE 652/09	CASTROVIEJO NH STR RA 9,0 CM	1
AR 250/15	MEASURING INSTRUMENT 15,0 CM	1
AR 282/20	CASTROVIEJO CIRCLE 8,0 CM STRAIGHT	1
KP 001/13	GREEN STRABISMUS HOOK 13,0 CM	1
KP 002/12	JAMESON MUSCLE HOOK 12,0 CM	1
KP 010/14	GASS RETINAL DETACHMENT HOOK 14,0 CM	1
KP 015/01	GRAEFE STRABISMUS HOOK #1 13,0 CM	1
KP 015/02	GRAEFE STRABISMUS HOOK #2 14,0 CM	1
KP 015/03	GRAEFE STRABISMUS HOOK #3 15,0 CM	1
KP 150/15	BARRAQUER-COLIBRI EYE SPECULA 15 MM 4,0 CM	1
KP 261/15	SAUTTER ORBITAL SPATUL MEDIUM 15,0 CM	1
KP 495/13	WECKER IRIS SPATULA 2MM SILVER 13,0 CM	1
KP 542/01	SCHIOETZ TONOMETER STRAIGHT SCALE	1
SK 305/05	WIRE BASKET, 485 X 255 X 50 MM	1

Sterilization Container KYE 200/61, if required



DIEFFENBACH

AA 060/06
6,0 cm/2 1/2"



HALSTED-MOSQUITO

AA 151/12
12,5 cm/5"



BACKHAUS

AA 751/08
8,0 cm/3"



GRAEFE

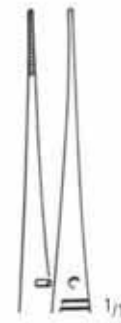

AB 710/07
7,0 cm/2 3/4"

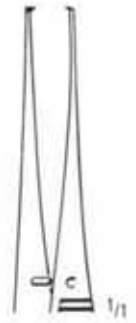

AB 714/07
7,0 cm/2 3/4"



BARRAQUER-KATZIN 1:2 (Colibri)
AB 750/07
7,0 cm/2 3/4"



ELSCHNIG 1:2
AB 792/11
11,0 cm/4 1/3"



CASTROVIEJO 1:2
AB 816/01 0,12 mm
10,0 cm/4"



10 x
0,12 mm



MOD. BONN
AB 825/02
10,0 cm/4"



PAUFIQUE 1:2
AB 828/10
10,0 cm/4"



Strabismusschere
Strabismus Scissors
Tijeras para estrabismo
Ciseaux à strabisme
Forbici per strabismo

mit großen Ringen
with large bows
con anillos grandes
avec grands anneaux
con anelli grandi

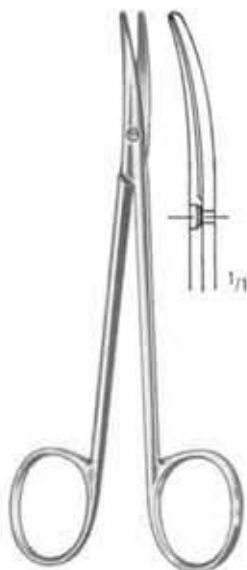

JAMESON
AB 833/01
10,0 cm/4"

JAMESON
AB 833/02
10,0 cm/4"

AC 461/11
11,5 cm/4 1/2"

AC 466/10
10,0 cm/4"

BARRAQUER
5,5 cm/2 1/4"
AC 768/05
5 mm



Fig. 11
AD 075/11

steril
sterile
estériles
stériles
sterili



WESTCOTT
AC 780/11
11,0 cm/4 1/3"

WESTCOTT
AC 782/11
11,0 cm/4 1/3"

TROUTMAN-CHRIS
AD 550/09
Ø 5,5 mm
9,0 cm/3 1/2"

BARRAQUER
AE 605/14
14,0 cm/5 1/2"

BARRAQUER
AE 607/14
14,0 cm/5 1/2"

CASTROVIEJO
AE 652/09
9,0 cm/3 1/2"



Messbereich 20 mm
measuring range 20 mm
campo de medición 20 mm
étendue de mesurage 20 mm
ampiezza di misura 20 mm



CASTROVIEJO
AR 282/20
8,0 cm/ 3"

AR 250/15
15,0 cm/6"

Erwachsene
Adults
Adultos
Adultes
Adulti

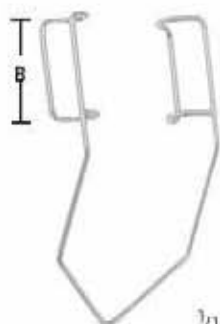

BARRAQUER-COLIBRI
B
15 mm
KP 150/15
4,0 cm/1 1/2"



GREEN
KP 001/13
13,0 cm/5"



JAMESON
KP 002/12
12,0 cm/4 3/4"



GASS
KP 010/14
14,0 cm/5 1/2"



GRAEFE
KP 015/01
13,0 cm/5"
Fig. 1



GRAEFE
KP 015/02
14,0 cm/5 1/2"
Fig. 2



GRAEFE
KP 015/03
15,0 cm/6"
Fig. 3

ZS 160/55 NETZHAUTABLÖSUNG RETINAL DETACHMENT DESPRENDIMIENTO DE RETINA
DÉCOLLEMENT DE LA RÉTINE DISTACCO DELLA RETINA



SAUTER
KP 261/15
15,0 cm/6"



WECKER
KP 495/13
13,0 cm/5"
2 mm

biegsam
malleable
maleable
malleable
malleabile



gerade Skala
straight scale
graduado recto
échelle droite
scala retta

SCHIOETZ
KP 542/01
13,0 cm/5"

Spezifikation Nr. 5, geeicht
Specification No. 5, calibrated
Especificación No. 5, calibrada
Spécification No. 5, calibrée
Specifica No. 5, calibrata



L(mm)	B(mm)	H(mm)	
485	255	50	SK 305/05

Contents:		Qty
AA 150/14	HALSTED-MOSQUITO ART.FCPS STR 14,0 CM	2
AA 151/14	HALSTED-MOSQUITO ART.FCPS CVD 14,0 CM	2
AA 711/09	JONES TOWEL FORCEPS 9,0 CM	2
AB 628/09	ZIEGLER CILIA FORCEPS 9,0 CM	1
AB 785/01	GRAEFE FIX.FCPS W/O SPRING CATCH 11,0 CM	1
AB 816/01	CASTROVIEJO SUTURE FORCEPS 10,0 CM	2
AB 824/02	BONACCOLTO SUTURE FORCEPS 10,0 CM FINE	1
AB 829/01	HARMS TYING FORCEPS STRAIGHT 10,0 CM	1
AB 840/01	DESMARRES CHALAZION FORCEPS FIG.1 9,0 CM	1
AB 841/01	LAMBERT CHALAZION FORCEPS 9,0 CM ROUND	1
AB 844/20	BERKE PTOSIS FORCEPS 11,0 CM, 20 MM	1
AC 450/10	IRIS SCISSORS STR SH/SH 10,5 CM	1
AC 475/10	STEVENS TENOTOM.SCS POINTED CVD 10,5 CM	1
AC 782/11	WESTCOTT TENOTOMY SCISSORS BLUNT 11,0 CM	1
AC 797/01	WESTCOTT STRABISMUS SCS STR SHARP 11,5 CM	1
AE 663/14	CASTROVIEJO NH CVD RA SERRATED 14,0 CM	1
AE 688/14	KALT MICRO-NEEDLE HOLDER STR 14,0 CM	1
AK 074/01	GUTHRIE DELICATE HOOK FIG.1 16,0 CM	1
AK 078/13	KNAPP DELICATE HOOK BLUNT 13,0 CM	1
AK 090/12	DESMARRES RETRACTOR 12 MM 13,0 CM	1
AK 090/14	DESMARRES RETRACTOR 14 MM 13,0 CM	1
AK 090/16	DESMARRES RETRACTOR 16 MM 13,0 CM	1
AR 282/20	CASTROVIEJO CIRCLE 8,0 CM STRAIGHT	1
KP 015/01	GRAEFE STRABISMUS HOOK #1 13,0 CM	1
KP 015/02	GRAEFE STRABISMUS HOOK #2 14,0 CM	1
KP 248/11	JAEGER LID PLATE 11,0 CM	1
KP 325/05	BONN SCLERA KNIFE 5MM 12,5 CM	1
KP 415/10	MEYHOEFER CHALAZION CURETTE 13,0 CM	1
KP 415/20	MEYHOEFER CHALAZIONCURETTE 13,0 CM 2,0 MM	1
KP 415/25	MEYHOEFER CHALAZIONCURETTE 13,0 CM 2,5 MM	1
KP 415/35	MEYHOEFER CHALAZIONCURETTE 13,0 CM 3,5 MM	1
KP 700/00	BISHOP-HARMON ANTERIOR CHAMBER	1
SK 305/05	WIRE BASKET, 485 X 255 X 50 MM	1

Sterilization Container KYE 200/61, if required

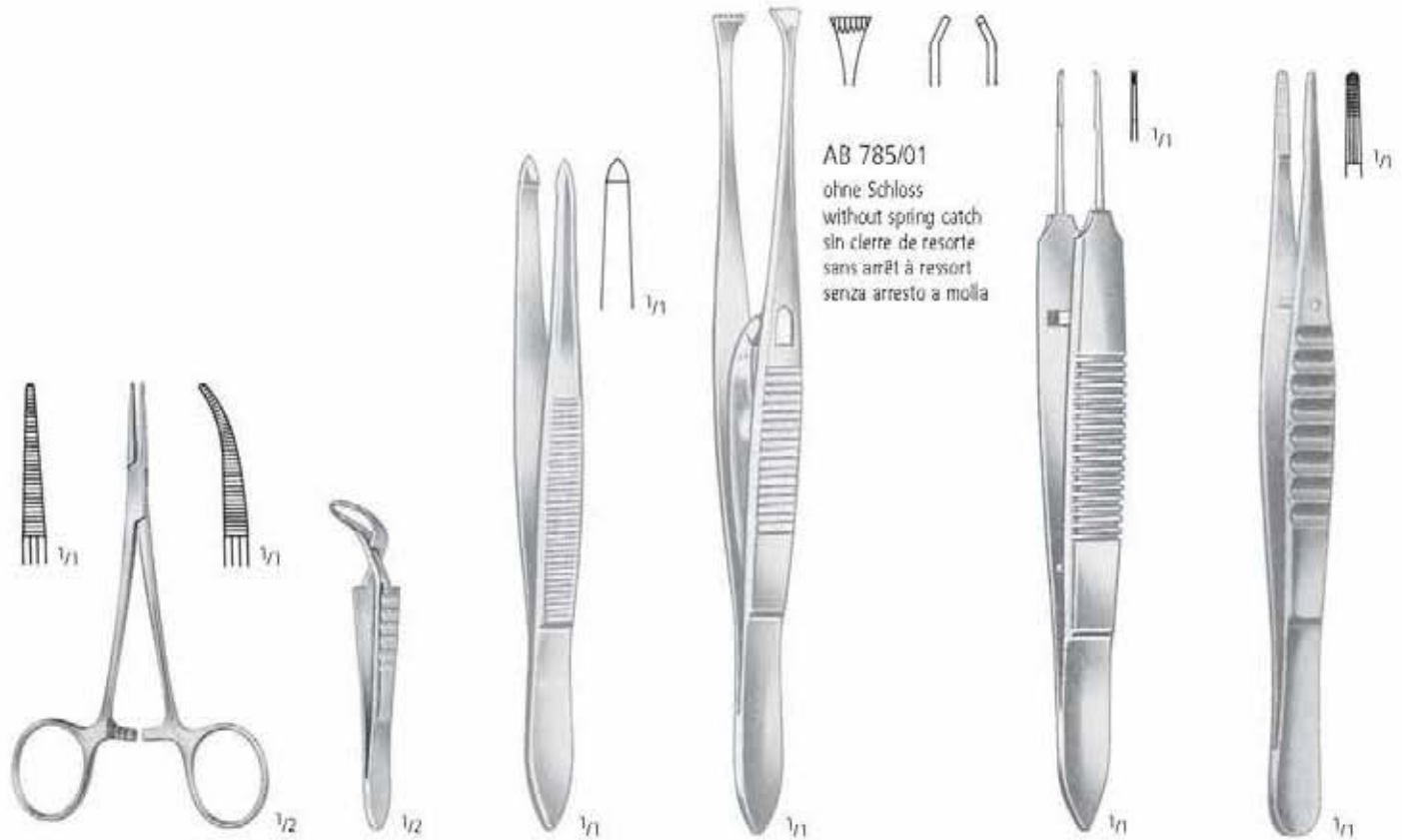

AB 785/01
ohne Schloss
without spring catch
sin cierre de resorte
sans arrêt à ressort
senza arresto a molla

HALSTED-MOSQUITO
AA 150/14 AA 151/14
14,0 cm/5 1/2"

JONES
AA 711/09
9,0 cm/3 1/2"

ZIEGLER
AB 628/09
9,0 cm/3 1/2"

GRAEFE
11,0 cm/4 1/3"

CASTROVIEJO 1:2
AB 816/01
0,12 mm
10,0 cm/4"

BONACCOLTO
AB 824/02
10,0 cm/4"



HARMS
AB 829/01
10,0 cm/4"



DESMARRES
AB 840/01
9,0 cm/3 1/2"



LAMPERT
AB 841/01
9,0 cm/3 1/2"



BERKE
AB 844/20
11,0 cm/4 1/3"
20 mm

Irisscheren
Iris Scissors
Tijeras para iridectomía
Ciseaux à iridectomie
Forbici per iridectomia



AC 450/10
10,5 cm/4 1/4"

Sehnenscheren
Tenotomy Scissors
Tijeras para tenotomía
Ciseaux à ténotomie
Forbici per tenotomia

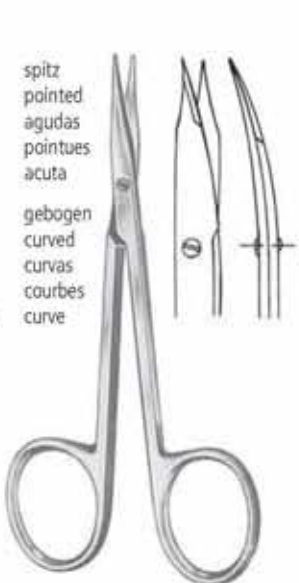

STEVENS
AC 475/10
10,5 cm/4 1/4"



WESTCOTT
AC 782/11
11,0 cm/4 1/3"

WESTCOTT
AC 797/01
11,5 cm/4 1/2"



CASTROVIEJO
AE 663/14
14,0 cm/5 1/2"

KALT
AE 688/14
14,0 cm/5 1/2"

Messbereich 20 mm
measuring range 20 mm
campo de medición 20 mm
étendue de mesurage 20 mm
ampiezza di misura 20 mm



CASTROVIEJO
AR 282/20
8,0 cm/ 3"

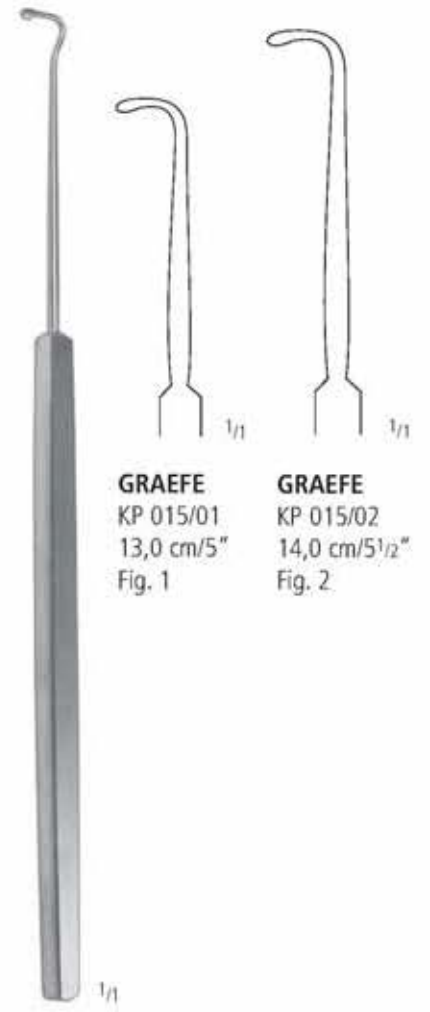

GRAEFE
KP 015/01
13,0 cm/5"
Fig. 1

GRAEFE
KP 015/02
14,0 cm/5 1/2"
Fig. 2



GUTHRIE
AK 074/01
16,0 cm/6 1/4"



KNAPP
AK 078/13
13,0 cm/5"



DESMARRES
13,0 cm/5"



AK 090/12
12 mm

AK 090/14
14 mm

AK 090/16
16 mm



JAEGER
KP 248/11
11,0 cm/4 1/2"

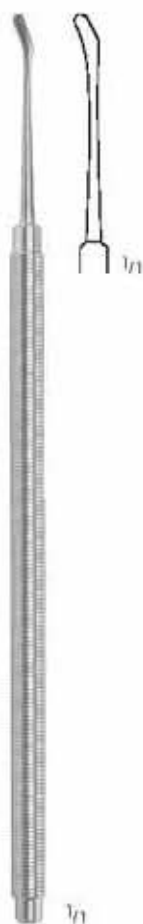

BONN
KP 325/05
12,5 cm/ 5"
5 mm



MEYHOEFER
13,0 cm/5"

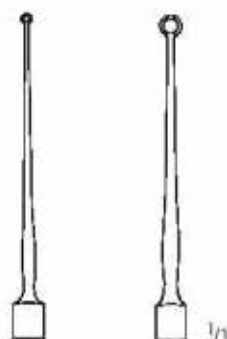

KP 415/10
Ø 1,0 mm

KP 415/20
Ø 2,0 mm

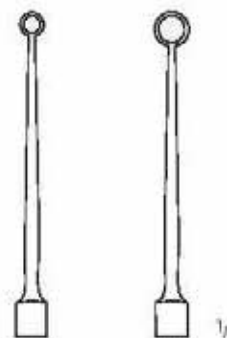

KP 415/25
Ø 2,5 mm

KP 415/35
Ø 3,5 mm

Set komplett
Set complete
Juego completo
Jeu complet
Set completo



BISHOP-HARMON
KP 700/00



L(mm)	B(mm)	H(mm)	
485	255	50	SK 305/05

ZS 160/65 PTERYGIUM PTERYGIUM PTERIGIÓN PTÉRYGION PTERIGIO

Contents:		Qty
AB 710/10	GRAEFE IRIS FORCEPS STR SERR. 10,0 CM	1
AB 714/10	GRAEFE IRIS FORCEPS STR 1X2 TEETH 10,0 CM	1
AB 786/02	GREEN FIXATION FORCEPS T-FORM 10,0 CM	1
AB 828/10	PAUFIQUE SUTURE FORCEPS 1X2 TEETH 10,0 CM	1
AC 466/10	IRIS SCISSORS STR W LARGE BOWS 10,0 CM	1
AE 657/14	CASTROVIEJO NH CVD SMOOTH 14,0 CM	1
AK 090/10	DESMARRES RETRACTOR 10 MM 13,0 CM	1
KP 186/08	LANCASTER EYE SPECULA 8,0 CM	1
KP 325/05	BONN SCLERA KNIFE 5MM 12,5 CM	1
SK 105/05	WIRE BASKET, 255 X 245 X 50 MM	

Sterilization Container KYE 200/11, if required

ZS 160/65 PTERYGIUM PTERYGIUM PTERIGIÓN PTÉRYGION PTERIGIO



GRAEFE



AB 710/10
10,0 cm/4"

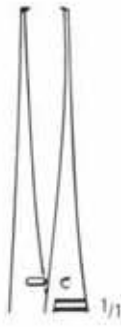

AB 714/10
10,0 cm/4"



GREEN
AB 786/02
10,0 cm/4"

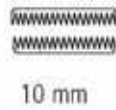

10 mm



PAUFIQUE 1:2
AB 828/10
10,0 cm/4"



mit großen Ringen
with large bows
con anillos grandes
avec grands anneaux
con anelli grandi



AC 466/10
10,0 cm/4"



CASTROVIEJO
AE 657/14
14,0 cm/5 1/2"



DESMARRES
AK 090/10
13,0 cm/5"



10 mm



LANCASTER
KP 186/08
8,0 cm/3 1/4"

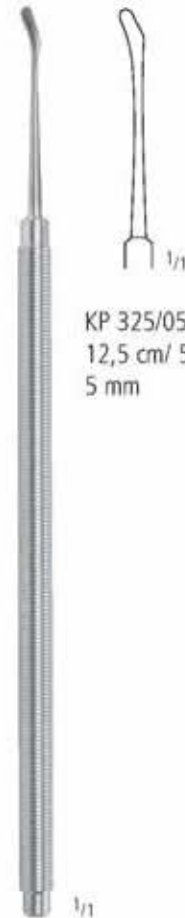

BONN

KP 325/05
12,5 cm/ 5"
5 mm



L(mm)	B(mm)	H(mm)	
255	245	50	SK 105/05

Contents:		Qty
AA 114/10	HARTMANN FORCEPS STR 10,0 CM	2
AA 115/10	HARTMANN FORCEPS CVD 10,0 CM	2
AA 751/08	BACKHAUS TOWEL FORCEPS 8,0 CM	2
AB 700/05	GRAEFE IRIS FCPS STR.SERRAT. 0,5 MM 7,0 CM	1
AB 816/01	CASTROVIEJO SUTURE FORCEPS 0,12MM 10,0 CM	1
AB 824/02	BONACCOLTO SUTURE FORCEPS 10,0 CM FINE	1
AB 828/10	PAUFIQUE SUTURE FORCEPS 1X2 TEETH 10,0 CM	1
AC 466/10	IRIS SCISSORS STR W LARGE BOWS 10,0 CM	1
AC 477/10	STEVENS TENOTOM.SCS BLUNT CVD 10,5 CM	1
AC 773/10	CASTROVIEJO IRIS SCISSORS 10,0 CM SH	1
AE 661/14	CASTROVIEJO NH CVD RA SMOOTH 14,0 CM	1
AK 077/13	KNAPP DELICATE HOOK SHARP 13,0 CM	1
KA 540/32	MEAD MALLET 320GR MASSIV FERROZ.FAC.17,0 CM	1
KA 800/14	FRIEDMANN RONGEUR FORCEPS 14,0 CM	1
KO 050/01	HARTMANN-HALLE NASAL SPEC.15,0 CM FIG.1	1
KO 275/90	KERRISON ANTRUM RONGEUR FCPS 3X3 MM	1
KO 343/16	JOSEPH SEPTUM ELEVATOR 16,0 CM	1
KO 603/04	FREER CHISELS CURVED 16,0 CM	1
KO 604/04	WEST CHISELS 16,0 CM	1
KO 605/04	WEST GOUGES 16,0 CM	1
KP 114/00	BOWMAN LACRIMAL PROBE POINTED 12,5 CM	1
KP 115/00	BOWMAN LACRIMAL PROBE POINTED 12,5 CM	1
KP 115/12	BOWMAN LACRIMAL PROBE POINTED 12,5 CM	1
KP 115/34	BOWMAN LACRIMAL PROBE POINTED 12,5 CM	1
KP 115/56	BOWMAN LACRIMAL PROBE POINTED 12,5 CM	1
KP 123/14	CASTROVIEJO LACRIMAL DILATOR,14,0 CM D/E	1
KP 135/14	WORST PIGTAIL PROBE 13,5 CM	1
KP 230/08	STEVENSON LACRIMAL SAC RETRACTOR 7,5 CM	1
KP 700/00	BISHOP-HARMON ANTERIOR CHAMBER	1
KP 740/23	ANEL LACRIMAL CANNULA 23G 4,0 CM	1
KP 741/23	LACRIMAL CANNULA 23G 4,0 CM CURVED	1
SK 305/05	WIRE BASKET, 485 X 255 X 50 MM	1

Sterilization Container KYE 200/61, if required



HARTMANN
 AA 114/10
 10,0 cm/4"

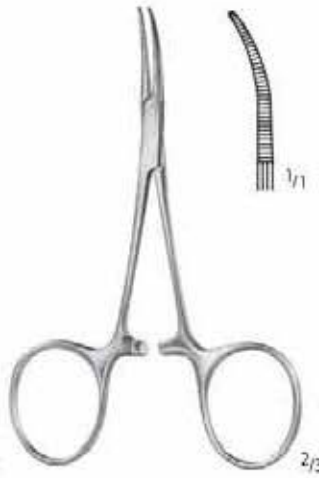

HARTMANN
 AA 115/10
 10,0 cm/4"



BACKHAUS
 AA 751/08
 8,0 cm/3"



GRAEFE
 0,5 mm
 AB 700/05
 7,0 cm/2 3/4"



CASTROVIEJO 1:2
 AB 816/01
 0,12 mm
 10,0 cm/4"



BONACCOLTO
 AB 824/02
 10,0 cm/4"



PAUFIGUE 1:2
 AB 828/10
 10,0 cm/4"



AC 466/10
 10,0 cm/4"

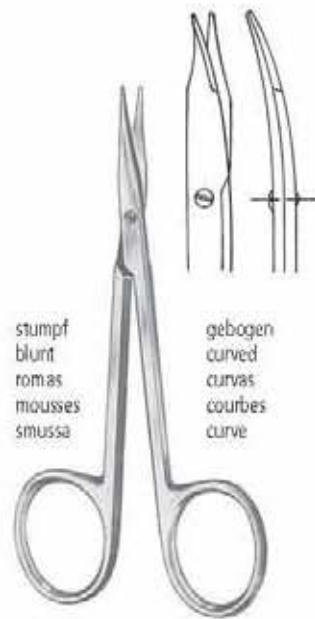

stumpf
 blunt
 romas
 mousses
 smussa

gebogen
 curved
 curvas
 courbes
 curve

STEVENS
 AC 477/10
 10,5 cm/4 1/4"

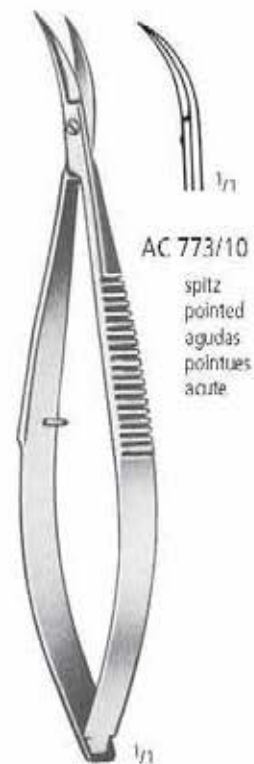

AC 773/10
 spitz
 pointed
 agudas
 pointues
 acute

CASTROVIEJO
 10,0 cm/4"

ZS 160/70

DACRYOCYSTORHINOSTOMIE
DACRYOCYSTORHINOSTOMIE

DACRYOCYSTORHINOSTOMY
DACRIOCISTORINOSTOMIA

DACRIOCISTORINOSTOMIA



CASTROVIEJO
AE 661/14
14,0 cm/5 1/2"



KNAPP
AK 077/13
13,0 cm/5"



MEAD
KA 540/32
17,0 cm/6 3/4"



FRIEDMAN
KA 800/14
14,0 cm/5 1/2"



HARTMANN-HALLE
KO 050/01
15,0 cm/6"



KERRISON



JOSEPH
KO 343/16
16,0 cm/6 1/4"



FREER
KO 603/04
16,0 cm/6 1/4"



WEST
KO 604/04
16,0 cm/6 1/4"



WEST
KO 605/04
16,0 cm/6 1/4"



geklopft
pointed
con botón
boutonné
bottenuto

aus Silber
Sterling silver
de plata pura
en argent pur
in argento puro

- KP 114/00
- KP 115/00
- KP 115/12
- KP 115/34
- KP 115/56

Fig.	mm Ø
0.000/00	0,4 / 0,6
00/0	0,7 / 0,8
1/2	0,9 / 1,1
3/4	1,3 / 1,4
5/6	1,5 / 1,6

BOWMAN
12,5 cm/5"



CASTROVIEJO
KP 123/14
14 cm/5 1/2"



WORST
KP 135/14
13,5 cm/5 1/4"



STEVENSON
KP 230/08
7,5 cm/3"



Set komplett
Set complete
Juego completo
Jeu complet
Set completo

BISHOP-HARMON
KP 700/00



ANEL
KP 740/23
4,0 cm/1 1/2"
23G



KP 741/23
3,5 cm/1 1/2"
23G



L(mm)	B(mm)	H(mm)	
485	255	50	SK 305/05

Contents:		Qty
AB 819/02	MCPHERSON TYING FORCEPS ANGLED 10,5 CM	1
KP 210/02	LIEBERMAN EYE SPECULA 15 MM K-SHAPE 8,0 CM	1
KP 211/08	LIEBERMAN EYE SPECULA 15 MM 8,0 CM ASP.	1
KP 270/10	LASIK FLAP SMOOTHER 10,0 CM	1
KP 487/14	CASTROVIEJO CYCLODIALYSIS SPATULA 13,5 CM	1
KP 489/12	BARRAQUER-FINO CYCLODIALYSIS SPATULA 11,5 CM	1
KP 516/11	LU CORNEAL MARKER LASIK Ø 8,5MM 10,5 CM	1
KP 550/12	THORNTON FIXATION RING FG-HINGE Ø 13,0 MM	1
KP 701/19	BISHOP-HARMON IRRIGATION CANNULA 19G 4,0 CM	1
KP 731/27	SAUTTER AIR INJECTION CANNULA 27G 3,5 CM	1
SK 105/05	WIRE BASKET, 255 X 245 X 50 MM	1

Sterilization Container KYE 200/11, if required



McPHERSON
AB 819/02
10,0 cm/4"



LIEBERMAN
KP 210/02
8,0 cm/3 1/4"
B = 15 mm



LIEBERMAN
KP 211/08
8,0 cm/3 1/4"
B = 15 mm



LASIK
KP 270/10
10,0 cm/4"



CASTROVIEJO
KP 487/14
13,5 cm/5 1/4"
0,5 x 10/16 mm

BARRAQUER-FINO
KP 489/12
11,5 cm/4 1/2"
0,25 x 12 mm

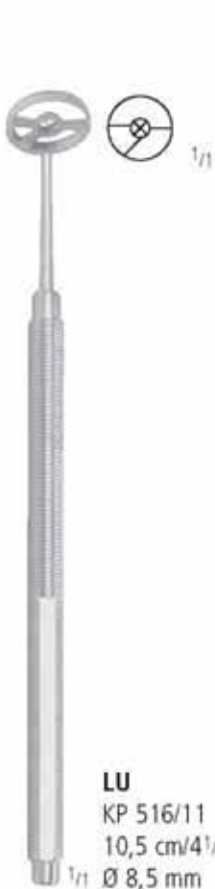

LU
KP 516/11
10,5 cm/4 1/4"
Ø 8,5 mm



THORNTON
KP 550/12
12,0 cm/4 3/4"
Ø 13 mm

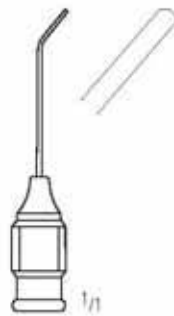

BISHOP-HARMON
KP 701/19
4,0 cm/1 1/2"
19G



SAUTTER
KP 731/27
3,5 cm/1 1/2"
27G



L(mm)	B(mm)	H(mm)	
255	245	50	SK 105/05

Contents:		Qty
AB 752/07	BARRAQUER-KATZIN IRIS FORCEPS 7,0 CM	1
AB 820/10	KELMAN-MCPHERSON TYING FORCEPS 10,0 CM	1
KP 154/04	BARRAQUER PHACO EYE SPECULA 4,0 CM	1
KP 375/02	PREMIUM DIAMOND KNIFE 1,0 CM 45°	1
KP 500/30	HOFFER OPTICAL ZONE MARKER 3,00 MM 10,0 CM	1
KP 500/32	HOFFER OPTICAL ZONE MARKER 3,25 MM 10,0 CM	1
KP 500/40	HOFFER OPTICAL ZONE MARKER 4.00 MM 10,0 CM	1
KP 500/50	HOFFER OPTICAL ZONE MARKER 5.00MM 10,0 CM	1
KP 500/70	HOFFER OPTICAL ZONE MARKER 7.00MM 10,0 CM	1
KP 535/12	ANIS SUTURE PLACEMENT MARKER 8 BLADES	1
KP 548/50	DEITZ DEPTH GAUGE 0,50 MM 9,5 CM	1
KP 548/55	DEITZ DEPTH GAUGE 0,55 MM 9,5 CM	1
KP 550/12	THORNTON FIXATION RING FG-HINGE Ø 13,0 MM	1
KP 731/27	SAUTTER AIR INJECTION CANNULA 27G 3,5 CM	2
SK 105/05	WIRE BASKET, 255 X 245 X 50 MM	1

Sterilization Container KYE 200/11, if required



BARRAQUER-KATZIN 1:2
(Colibri)
AB 752/07
7,0 cm/2³/₄"



BARRAQUER PHAKO
KP 154/04
4,0 cm/1¹/₂"



mit Mikrometer
with micrometer
con micrómetro
avec micromètre
con micrometro

- Ø 3,00 mm
- Ø 3,25 mm
- Ø 4,00 mm
- Ø 5,00 mm
- Ø 7,00 mm



HOFFER
10,0 cm/4"

KELMAN-McPHERSON 1:2
AB 820/10
10,0 cm/4"

KP 375/02



ANIS
KP 535/12
12,0 cm/4³/₄"



DEITZ
9,5 cm/3³/₄"
KP 548/50 0,50 mm
KP 548/55 0,55 mm



THORNTON
KP 550/12
12,0 cm/4³/₄"
Ø 13 mm



SAUTTER
KP 731/27
3,5 cm/1¹/₂"
27G



L(mm)	B(mm)	H(mm)	
255	245	50	SK 105/05

Contents:		Qty
AA 060/03	DIEFFENBACH BULLDOG CLAMPS STR 3,5 CM	2
AA 114/10	HARTMANN FORCEPS STR 10,0 CM	2
AA 150/12	HALSTED-MOSQUITO FCPS STR 12,5 CM	2
AA 711/09	JONES TOWEL FORCEPS 9,0 CM	2
AA 751/13	BACKHAUS TOWEL FORCEPS 13,0 CM	2
AB 710/10	GRAEFE IRIS FORCEPS STR SERR. 10,0 CM	1
AB 750/07	BARRAQUER-KATZIN FIX.FCPS 1X2 T. 7,0 CM	1
AB 816/01	CASTROVIEJO SUTURE FORCEPS 10,0 CM	2
AB 824/02	BONACCOLTO SUTURE FORCEPS 10,0 CM FINE	1
AB 825/02	BONN SUTURE FORCEPS 10,0 CM ULTRA FINE	2
AB 848/11	FAULKNER LENS HOLDING FORCEPS 11,0 CM	1
AC 466/10	IRIS SCISSORS STR W LARGE BOWS 10,0 CM	1
AC 467/10	IRIS SCISSORS CVD W LARGE BOWS 10,0 CM	1
AC 474/11	STEVENS TENOTOM.SCS.STR POINTED 11,5 CM	1
AC 776/01	VANNAS MOD.TÜBINGEN STRAIGHT 8,5 CM	1
AC 780/11	WESTCOTT TENOTOMY SCS.POINTED 11,0 CM	1
AE 657/14	CASTROVIEJO NH CVD SMOOTH 14,0 CM	1
AE 660/14	CASTROVIEJO NH STR RA SMOOTH 14,0 CM	1
AR 282/20	CASTROVIEJO CIRCLE 8,0 CM STRAIGHT	1
KP 002/12	JAMESON MUSCLE HOOK 12,0 CM	2
KP 010/14	GASS RETINAL DETACHMENT HOOK 14,0 CM	2
KP 211/08	LIEBERMAN EYE SPECULA 15 MM 8,0 CM ASP.	1
KP 261/15	SAUTTER ORBITAL SPATUL MEDIUM 15,0 CM	1
KP 262/13	ARRUGA PROTECTOR 13,0 CM	1
KP 354/12	FOREIGN BODY NEEDLE STRAIGHT 12,0 CM	1
KP 390/00	VITRECTOMY SCISSORS STRAIGHT SMOOTH 0°	1
KP 394/00	VITRECTOMY GRASPING FCPS STRAIGHT SMOOTH	1
KP 700/00	BISHOP-HARMON ANTERIOR CHAMBER	1
KP 760/21	INJECTION CANNULA 21G 4,5 CM	1
SK 305/05	WIRE BASKET, 485 X 255 X 50 MM	1

Sterilization Container KYE 200/61, if required



DIEFFENBACH
 AA 060/03
 3,5 cm/1 1/2"

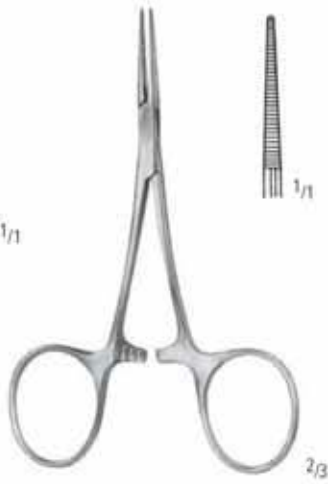

HARTMANN
 AA 114/10
 10,0 cm/4"



HALSTED-MOSQUITO
 AA 150/12
 12,5 cm/5"



JONES
 AA 711/09
 9,0 cm/3 1/2"



BACKHAUS
 AA 751/13
 13,0 cm/5"

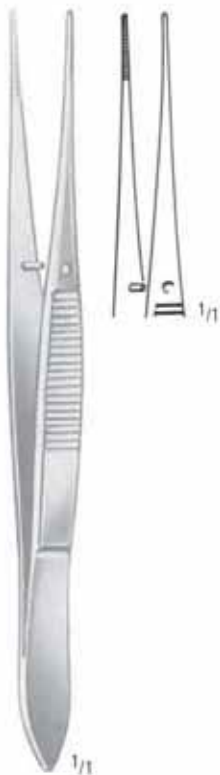

GRAEFE
 AB 710/10
 10,0 cm/4"



BARRAQUER-KATZIN 1:2 (Colibri)
 AB 750/07
 7,0 cm/2 3/4"



CASTROVIEJO 1:2
 AB 816/01
 0,12 mm
 10,0 cm/4"



BONACCOLTO
 AB 824/02
 10,0 cm/4"



MOD. BONN
 AB 825/02
 10,0 cm/4"



FAULKNER
 AB 848/11
 11,0 cm/4 1/3"

ZS 160/85

VITREKTOMIE (PARS PLANA) VITRECTOMY (PARS PLANA) VITRECTOMÍA PARS-PLANA
 VITRECTOMIE (PARS PLANA) VITRECTOMIA PARS-PLANA

mit großen Ringen
 with large bows
 con anillos grandes
 avec grands anneaux
 con anelli grandi

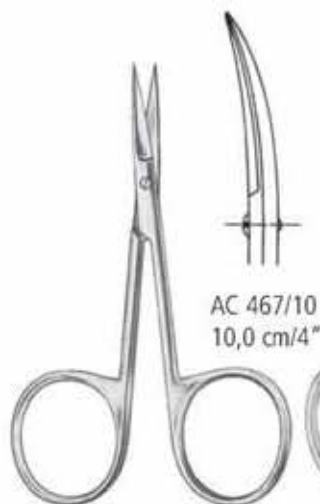

AC 466/10
 10,0 cm/4"

spitz
 pointed
 agudas
 pointues
 acuta



STEVENS
 AC 474/11
 11,5 cm/4 1/2"

gerade
 straight
 rectas
 droits
 rette



VANNAS MOD.
 TÜBINGEN
 AC 776/01
 8,5 cm/3 1/3"

gerade
 straight
 rectas
 droits
 rette



WESTCOTT
 AC 780/11
 11,0 cm/4 1/3"



CASTROVIEJO
 AE 657/14
 14,0 cm/5 1/2"



CASTROVIEJO
 AE 660/14
 14,0 cm/5 1/2"

Messbereich 20 mm
 measuring range 20 mm
 campo de medición 20 mm
 étendue de mesure 20 mm
 ampiezza di misura 20 mm



CASTROVIEJO
 AR 282/20
 8,0 cm/ 3"



JAMESON
 KP 002/12
 12,0 cm/4 3/4"



GASS
 KP 010/14
 14,0 cm/5 1/2"

T
 B



LIEBERMAN
 KP 211/08
 8,0 cm/3 1/4"
 B = 15 mm



SAUTTER
 KP 261/15
 15,0 cm/6"

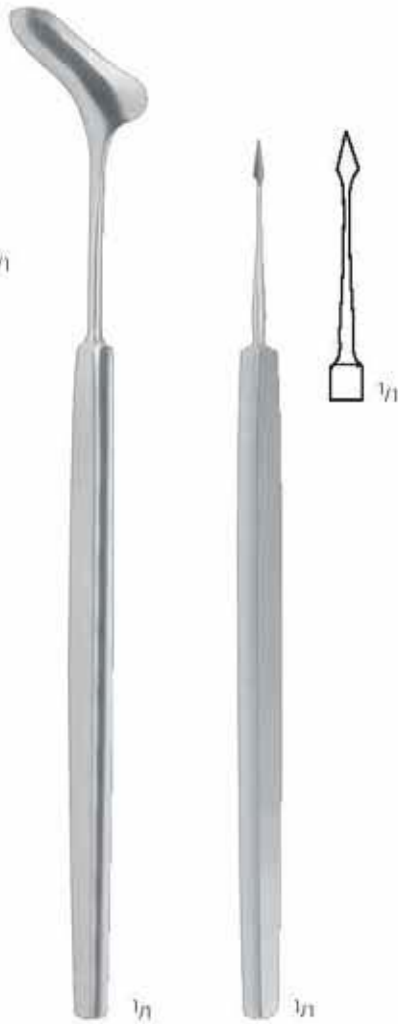

ARRUGA
 KP 262/13
 13,0 cm/5"



KP 354/12
 12,0 cm/ 4³/₄"



KP 390/00
 0°

ohne Spülung
 without irrigation
 sin irrigación
 sans irrigation
 senza irrigazione

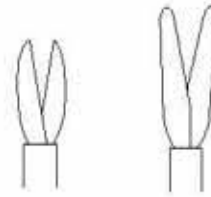

KP 394/00



BISHOP-HARMON
 KP 700/00

Set komplett
 Set complete
 Juego completo
 Jeu complet
 Set completo

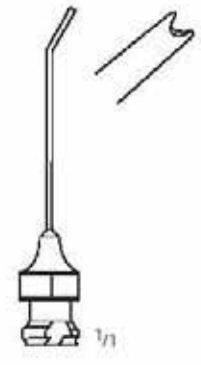

KP 760/21
 4,5 cm/2"
 21G



L(mm)	B(mm)	H(mm)	
485	255	50	SK 305/05

KLEMMEN
HEMOSTATS
PINZAS HEMOSTATICAS
PINCES HEMOSTATIQUES
PINZE EMOSTATICHE

AA

nopa[®] instruments

Weitere Klemmen finden Sie in unserem Katalog „Allgemeines Instrumentarium“ in Gruppe AA.

For further hemostats kindly refer to our catalogue "General Instruments", section AA.

Para pinzas hemostaticas adicionales, por favor consulte nuestro catálogo de "Instrumental de uso general", grupo AA.

Pour des pinces hemostatiques supplémentaires, consultez notre catalogue „Instrumentation Generale“, section AA.

Per gli altri pinze emostatiche, consultare il nostro catalogo "Strumentazione Generale", gruppo AA.



Bulldogklemmen, Anlegezangen
 Bulldog Clamps, Setting Forceps
 Clamps Bulldog, Pinza para poner
 Clamps Bulldog, Pinze à poser
 Pinze Bulldog, Pinza per posizionare

AA
 AB
 AC
 AD
 AE
 AK
 AR
 KA
 KM
 KO
 KP
 XR



DIEFFENBACH

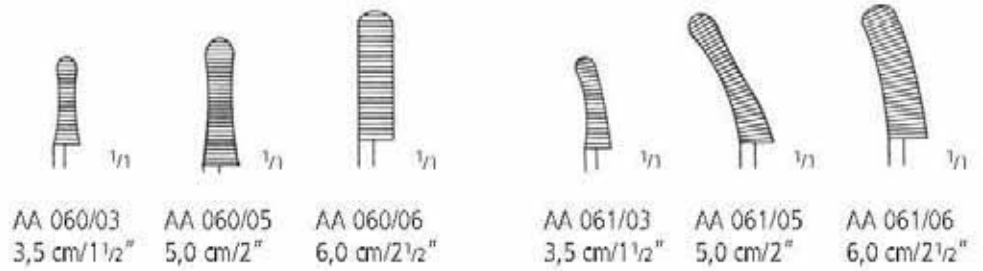

JOHNS-HOPKINS
 AA 069/24
 24,5 cm/9 3/4"



JOHNS-HOPKINS

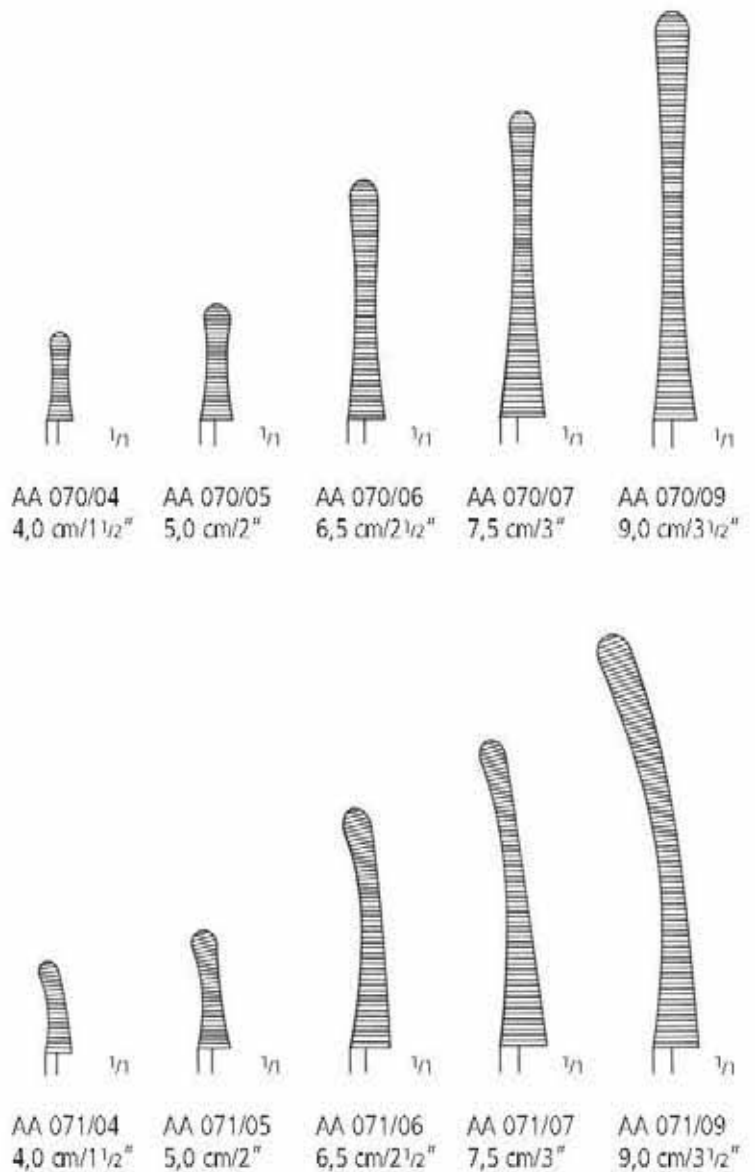

Arterienklemmen
Artery Forceps
Pinzas hemostáticas
Pincas hémostatiques
Pinze emostatiche

T = TITAN

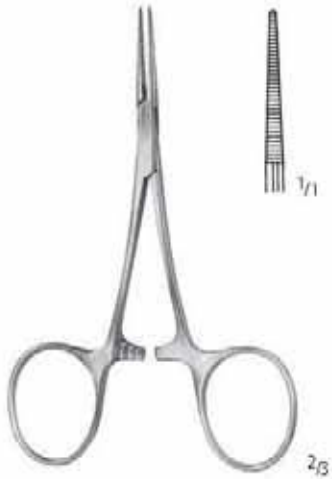

HARTMANN
AA 114/10
AA 114/10 T
10,0 cm/4"



HARTMANN
AA 115/10
AA 115/10 T
10,0 cm/4"

WILLIAM STEWART HALSTED
was professor of surgery in the Johns Hopkins University. In 1890 he had bronze casts made of his own hands. On these casts the first surgical rubber gloves were moulded.



HALSTED-MOSQUITO
AA 150/12 AA 151/12
AA 150/12 T AA 151/12 T
AA 150/14 AA 151/14

12,5 cm/5"
12,5 cm/5"
14,0 cm/5½"

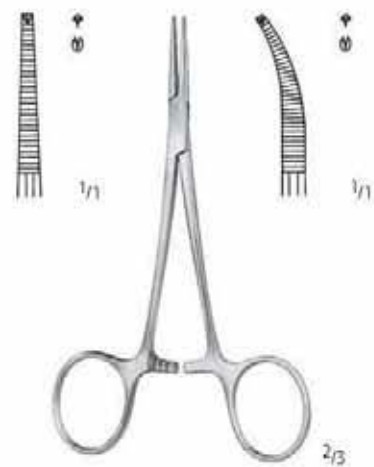

HALSTED-MOSQUITO 1:2
AA 152/12 AA 153/12
AA 152/12 T AA 153/12 T
AA 152/14 AA 153/14

Tuchklemmen
Towel Forceps
Pinzas para compresas, Pinzas de campo
Pincés à champs, Pincés à compresses
Pinze per fissare le compresse (fissarele)



SCHAEDEL
AA 710/09
9,0 cm/3 1/2"



JONES
5,0 cm/2"
9,0 cm/3 1/2"
AA 711/05
AA 711/09



AA 749/11
11,0 cm/4 1/2"

mit Schlauch- oder Kabelhalter
with clip for tubing or cable
con porta-tubo o porta-cable
avec clamp porte-tube ou porte-
-corton d'alimentation
con porta tubo o porta cavo



BACKHAUS
8,0 cm/3 1/4" AA 751/08
11,0 cm/4 1/2" AA 751/11
13,0 cm/5" AA 751/13
15,0 cm/6" AA 751/15



ROEDER
13,0 cm/5" AA 761/13
15,0 cm/6" AA 761/15

AA

AB

AC

AD

AE

AK

AR

KA

KM

KO

KP

XR

Tuchklemmen
Towel Forceps
Pinzas para compresas, Pinzas de campo
Pinces à champs, Pinces à compresses
Pinze per fissare le compresse (fissarele)



LORNA

10,0 cm/4" AA 763/10
13,0 cm/5" AA 763/13



TOHOKU-JAPAN

10,0 cm/4" AA 764/10
13,0 cm/5" AA 764/13

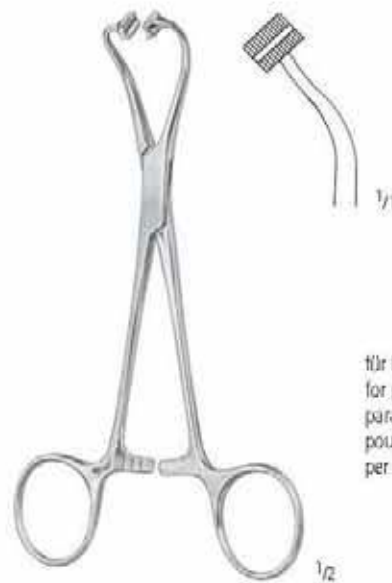

PEERS

AA 765/14
14,5 cm/5³/₈"

für Papiertücher
for paper tissues
para servilletas de papel
pour serviettes en papier
per tessuti di carta

PINZETTEN
FORCEPS
PINZAS
PINCES
PINZE

AB

nopa[®] instruments

Weitere Pinzetten finden Sie in unserem Katalog „Allgemeines Instrumentarium“ in Gruppe AB.

For further forceps kindly refer to our catalogue "General Instruments", section AB.

Para pinzas adicionales, por favor consulte nuestro catálogo de "Instrumental de uso general", grupo AB.

Pour des pinces supplémentaires, consultez notre catalogue „Instrumentation Generale“, section AB.

Per gli altri pinze, consultare il nostro catalogo "Strumentazione Generale", gruppo AB.



Anatomische Pinzetten, Chirurgische Pinzetten
 Dressing Forceps, Tissue forceps
 Pinzas de disección, Pinzas de disección con dientes
 Pincers à dissection, Pincers a griffes
 Pinze anatomiche per dissezione, Pinze chirurgiche a denti di topo

T = TITAN



AB 100/12



AB 102/12



AB 110/12



AB 112/12

12,0 cm/4³/₄"
 12,0 cm/4³/₄"
 15,0 cm/6"

ADSON
 AB 100/12
 AB 100/12 T
 AB 100/15

MICRO-ADSON
 AB 102/12
 AB 102/15

ADSON 1:2
 AB 110/12
 AB 110/12 T
 AB 110/15

MICRO-ADSON 1:2
 AB 112/12
 AB 112/15



7 : 7
 AB 116/07
 AB 116/07 T

9 : 9
 AB 116/09

ADSON-BROWN

12,0 cm/4³/₄"



9 : 9

ADSON-BROWN

AB 117/09
 12,0 cm/4³/₄"

PINZETTEN FORCEPS PINZAS PINCES PINZE

Cilienpinzetten
Cilia Forceps
Pinzas de depilatorias
Pincas à épiler les cils
Pinze depilatorie



LITTAUER
AB 620/08
8,5 cm/3 1/2"



AB 621/09
9,0 cm/3 1/2"



DOUGLAS
AB 624/09
9,0 cm/3 1/2"



BEER
AB 626/09
9,0 cm/3 1/2"



ZIEGLER
AB 628/09
9,0 cm/3 1/2"



BARRAQUER
AB 633/10
10,5 cm/4 1/4"



GRADLE
AB 635/09
9,5 cm/3 3/4"

AA

AB

AC

AD

AE

AK

AR

KA

KM

KO

KP

XR

AB PINZETTEN FORCEPS PINZAS PINCES PINZE

Irispinzetten
Iris Forceps
Pinzas para iris
Pincès à iris
Pinze per iride



AB 700/07

GRAEFE
7,0 cm/2³/₄"

0,5 mm AB 700/05
0,7 mm AB 700/07
1,0 mm AB 700/10



AB 701/07

GRAEFE
7,0 cm/2³/₄"

AB 701/05
AB 701/07
AB 701/10



AB 702/07

GRAEFE 1:2
7,0 cm/2³/₄"

AB 702/05
AB 702/07
AB 702/10



AB 703/07

GRAEFE 1:2
7,0 cm/2³/₄"

AB 703/05
AB 703/07
AB 703/10



GRAEFE



7,0 cm/2³/₄" AB 710/07
10,0 cm/4" AB 710/10

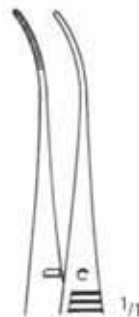

AB 711/07
AB 711/10

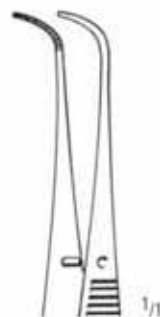

AB 713/07
AB 713/10

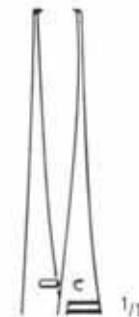

AB 714/07
AB 714/10

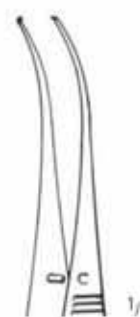

AB 715/07
AB 715/10

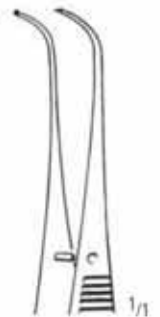

AB 717/07
AB 717/10

PINZETTEN FORCEPS PINZAS PINCES PINZE

Irispinzetten
Iris Forceps
Pinzas para iris
Pincas à iris
Pinze per iride



STEVENS 1:2
AB 718/01
11,0 cm/4¹/₂"



STEVENS 1:2
AB 718/02
11,0 cm/4¹/₂"



STEVENS
10,5 cm/4¹/₂"



AB 720/01



AB 720/02



AB 720/03



AB 721/01 1:2



AB 721/02 1:2



AB 721/03 1:2



FISCHER-ARLT 1:2
AB 723/07
7,0 cm/2³/₄"

AA
AB
AC
AD
AE
AK
AR
KA
KM
KO
KP
XR

AB PINZETTEN FORCEPS PINZAS PINCES PINZE

Irispinzetten
Iris Forceps
Pinzas para iris
Pincès à iris
Pinze per iride



FOERSTER
AB 726/08
8,5 cm/3¹/₂"



FOERSTER
AB 727/08
8,5 cm/3¹/₂"



FOERSTER 1:2
AB 728/08
8,5 cm/3¹/₂"



FOERSTER 1:2
AB 729/08
8,5 cm/3¹/₂"



HESS 1:2
AB 730/07
7,0 cm/2³/₄"



HESS 1:2
AB 731/09
9,0 cm/3¹/₂"



MOD. BONN 1:2
AB 734/01
7,0 cm/2³/₄"



MOD. BONN 1:2
AB 734/02
7,0 cm/2³/₄"

PINZETTEN FORCEPS PINZAS PINCES PINZE

Irispinzetten
Iris Forceps
Pinzas para iris
Pincas à iris
Pinze per iride

AA

AB

AC

AD

AE

AK

AR

KA

KM

KO

KP

XR



MOD. BONN
7,0 cm/2³/₄"

AB 735/01

AB 735/02



BISHOP-HARMON
8,5 cm/3¹/₂"

AB 736/08

AB 738/08

1:2



BISHOP-HARMON
8,5 cm/3¹/₂"

AB 740/08



AB 742/08

10 x
fein
fine
fina
fine
fina
fina

1:2



KIRBY 1:2
AB 748/09
9,0 cm/3¹/₂"



BARRAQUER-KATZIN 1:2
(Colibri)
AB 750/07
7,0 cm/2³/₄"

10 x



10 x



10 x

AB PINZETTEN FORCEPS PINZAS PINCES PINZE

Irispinzetten, Kapselpinzetten
 Iris Forceps, Capsular Forceps
 Pinzas para iris, Pinzas capsulares
 Pincès à iris, Pincès capsulaires
 Pinze per iride, Pinze capsulari



10 x

TROUTMAN 1:2
(Corneal)
 AB 751/07
 7,5 cm/3"



10 x

BARRAQUER-KATZIN 1:2
(Colibri)
 AB 752/07
 7,0 cm/2³/₄"

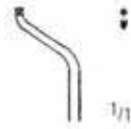

AB 756/07

Zähne seitwärts
 teeth on side
 dientes laterales
 dents latérales
 denti laterali



AB 757/07

Zähne unten
 teeth below
 dientes inferiores
 dents en bas
 denti in basso



GILL-HESS 1:2
 7,5 cm/3"



10 x

0,3 mm

GILL 1:2
 AB 762/07
 7,5 cm/3"



GILL-FUCHS
 AB 763/07
 7,5 cm/3"



TERSON
 AB 765/09
 9,0 cm/3¹/₂"



CASTROVIEJO
 AB 767/01
 10,0 cm/4"



CASTROVIEJO
 AB 767/02
 10,0 cm/4"

PINZETTEN FORCEPS PINZAS PINCES PINZE

Kapselpinzetten, Fixierpinzetten
 Capsular Forceps, Fixation Forceps
 Pinzas capsulares, Pinzas de fijación
 Pincas capsulaires, Pincas à fixer
 Pinze capsulari, Pinze fissatrici

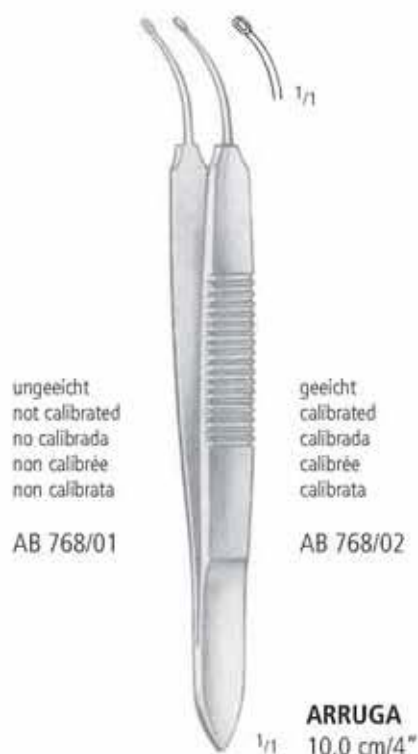

geeicht
 calibrated
 calibrada
 calibrée
 calibrata

AB 768/02

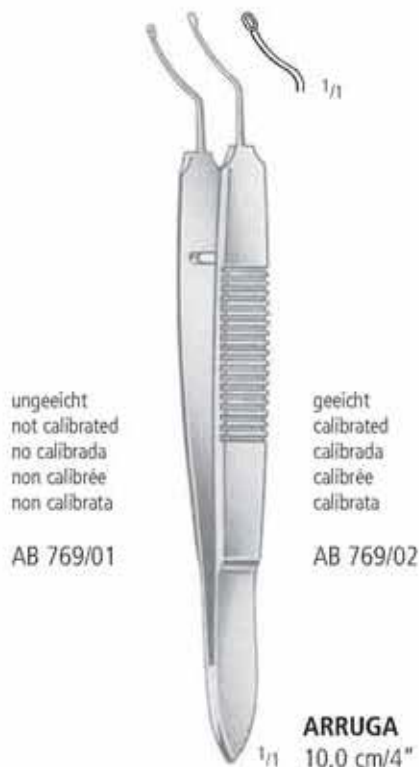

geeicht
 calibrated
 calibrada
 calibrée
 calibrata

AB 769/02



AB 785/02

mit Schloss
 with spring catch
 con cierre de resorte
 avec arrêt à ressort
 con arresto a molla



AB 786/02

AA
 AB
 AC
 AD
 AE
 AK
 AR
 KA
 KM
 KO
 KP
 XR

AB PINZETTEN FORCEPS PINZAS PINCES PINZE

Fixierpinzetten, Nahtpinzetten
 Fixation Forceps, Suture Forceps
 Pinzas de fijación, Pinzas para sutura
 Pincés à fixer, Pincés pour sutures
 Pinze fissatrici, Pinze per sutura



PINZETTES FORCEPS PINZAS PINCES PINZE

Nahtpinzetten
Suture Forceps
Pinzas para sutura
Pincas pour sutures
Pinze per sutura

AA

AB

AC

AD

AE

AK

AR

KA

KM

KO

KP

XR

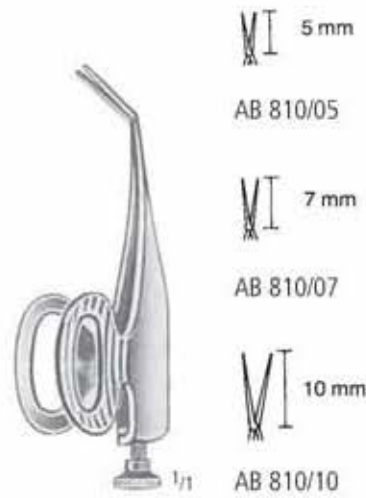

5 mm

AB 810/05

7 mm

AB 810/07

10 mm

AB 810/10

BARRAQUER
5,5 cm/2¹/₄"



ST. MARTIN 1:2
AB 812/07
7,0 cm/2³/₄"

Vorderkammer-Pinzetten
Anterior Chamber Forceps
Pinzas para la cámara anterior
Pincas pour la chambre antérieure
Pinze per la camera anteriore



AB 816/01

0,12 mm
0,30 mm
0,50 mm
1,00 mm
1,50 mm

AB 816/01
AB 816/03
AB 816/05
AB 816/10
AB 816/15

CASTROVIEJO 1:2
10,0 cm/4"



AB 817/01

AB 817/01
AB 817/03
AB 817/05
AB 817/10
AB 817/15

CASTROVIEJO 1:2
10,0 cm/4"



AB 819/01

AB 819/02

McPHERSON
10,0 cm/4"

AB PINZETTEN FORCEPS PINZAS PINCES PINZE

Nahtpinzetten
Suture Forceps
Pinzas para sutura
Pinces pour sutures
Pinze per sutura



KELMAN-McPHERSON 1:2
AB 820/10
10,0 cm/4"



BONACCOLTO
AB 824/01
10,0 cm/4"



BONACCOLTO
AB 824/02
10,0 cm/4"



MOD. BONN
10,0 cm/4"



MOD. TÜBINGEN
AB 826/10
10,0 cm/4"

PINZETTEN FORCEPS PINZAS PINCES PINZE

Nahtpinzetten, Fadenpinzetten
 Suture Forceps, Suture Tying Forceps
 Pinzas para sutura, Pinzas de ligadura
 Pincés pour sutures, Pincés à ligature
 Pinze per sutura, Pinze per ligature



PAUFIQUE 1:2
 AB 828/10
 10,0 cm/4"



HARMS
 AB 829/01
 10,0 cm/4"



HARMS
 AB 829/02
 10,0 cm/4"

AA

AB

AC

AD

AE

AK

AR

KA

KM

KO

KP

XR

AB PINZETTEN FORCEPS PINZAS PINCES PINZE

Muskelpinzetten
Muscular Forceps
Pinzas musculares
Pincès musculaires
Pinze muscolari

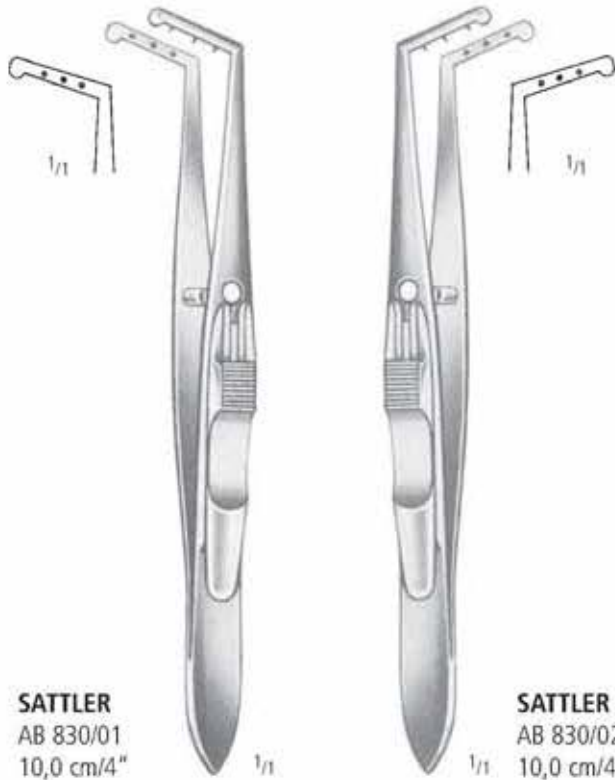

SATTLER
AB 830/01
10,0 cm/4"

SATTLER
AB 830/02
10,0 cm/4"



BLASCOVICS
AB 832/01
9,0 cm/3 1/2"

BLASCOVICS
AB 832/02
9,0 cm/3 1/2"



JAMESON
AB 833/01
10,0 cm/4"

JAMESON
AB 833/02
10,0 cm/4"

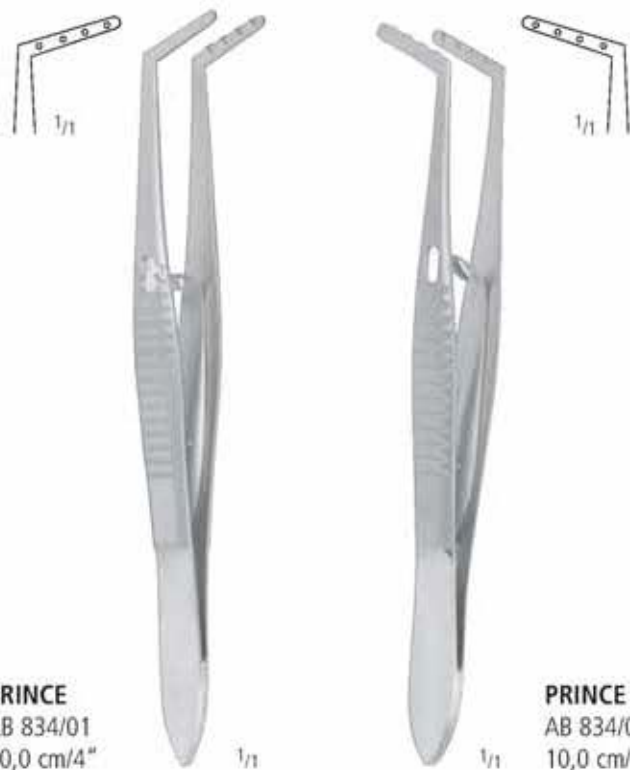

PRINCE
AB 834/01
10,0 cm/4"

PRINCE
AB 834/02
10,0 cm/4"

PINZETTEN FORCEPS PINZAS PINCES PINZE

Muskelpinzetten, Entropium- und Chalazionpinzetten
 Muscular forceps, Entropium and Chalazion forceps
 Pinzas musculares, Pinzas de entropión y de chalazión
 Pincès musculaires, Pincès à entropion et à chalazion
 Pinze muscolari, Pinze per palpebre (entropio) e per calazio



BERENS
 AB 835/09
 8,5 cm/3 1/2"



ERHARDT
 AB 836/09
 9,0 cm/3 1/2"



SNELLEN
 AB 837/01
 10,0 cm/4"



SNELLEN
 AB 837/02
 10,0 cm/4"



AYER
 AB 838/01
 9,0 cm/3 1/2"



AYER
 AB 838/02
 9,0 cm/3 1/2"



DESMARRES
 9,0 cm/3 1/2"



AB 840/01

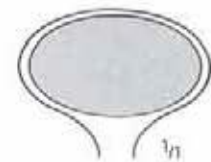

AB 840/02

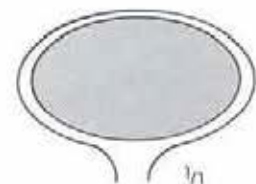

AB 840/03

AA

AB

AC

AD

AE

AK

AR

KA

KM

KO

KP

XR

Chalazionpinzetten, Ptosispinzetten
 Chalazion forceps, Ptosis forceps
 Pinzas de chalazión, Pinzas para ptosis
 Pincès à chalazion, Pincès à ptosis
 Pinze per calazio, Pinze per ptosis



LAMBERT
 AB 841/01
 9,0 cm/3 1/2"



LAMBERT
 AB 841/02
 9,0 cm/3 1/2"



BERKE
 AB 844/20
 11,0 cm/4 1/2"
 20 mm



BERKE
 AB 844/27
 11,0 cm/4 1/2"
 27 mm

PINZETTEN FORCEPS PINZAS PINCES PINZE

Linsenhalte- und Kapsulorhexispinzetten
 Lens Holding and Capsulorhexis Forceps
 Pinzas para tener cristalino y capsulorhexis
 Pincès à tenir de cristallins et capsulorhexis
 Pinze per tenere il cristallino, Pinze capsulorhexis

AA

AB

AC

AD

AE

AK

AR

KA

KM

KO

KP

XR



FAULKNER
 AB 848/11
 11,0 cm/4 1/2"



McDONALD
 AB 852/01
 10,0 cm/4"



McDONALD
 AB 852/02
 10,0 cm/4"

SCHEREN
SCISSORS
TIJERAS
CISEAUX
FORBICI

AC

nopa[®] instruments

Weitere Scheren finden Sie in unserem Katalog „Allgemeines Instrumentarium“ in Gruppe AC.

For further scissors kindly refer to our catalogue "General Instruments", section AC.

Para tijeras adicionales, por favor consulte nuestro catálogo de "Instrumental de uso general", grupo AC.

Pour des ciseaux supplémentaires, consultez notre catalogue „Instrumentation Generale“, section AC.

Per gli altri forbici, consultare il nostro catalogo "Strumentazione Generale", gruppo AC.



SCHEREN SCISSORS TIJERAS CISEAUX FORBICI

Feine Scheren, Augenscheren
 Fine Scissors, Eye Scissors
 Tijeras finas, Tijeras oculares
 Ciseaux fins, Ciseaux oculaires
 Forbici fini, Forbici oftalmologici

AA

AB

AC

AD

AE

AK

AR

KA

KM

KO

KP

XR

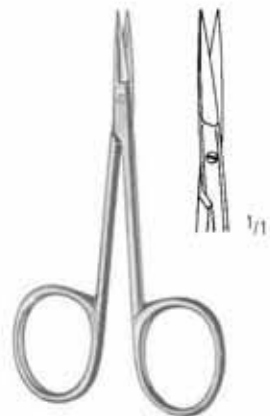

AC 430/08
 8,0 cm/3 1/4"

MOD. BONN

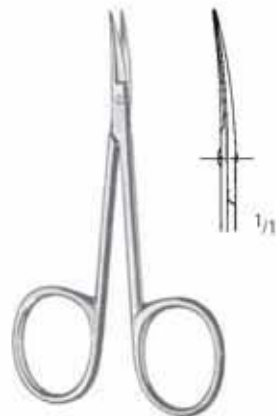

AC 431/08
 8,0 cm/3 1/4"



11,5 cm/4 1/2"

Fig. 1

gerade
 straight
 rectas
 droits
 rette

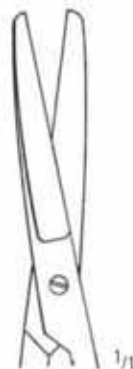

AC 446/01

Fig. 2



AC 446/02

Fig. 1

gebogen
 curved
 curvas
 courbes
 curve



AC 447/01

Fig. 2



AC 447/02

AC SCHEREN SCISSORS TIJERAS CISEAUX FORBICI

Augenscheren
Eye Scissors
Tijeras oculares
Ciseaux oculaires
Forbici oftalmologici



AC 448/11
11,5 cm/4 1/2"



AC 449/11
11,5 cm/4 1/2"

Irisscheren
Iris Scissors
Tijeras para iridectomia
Ciseaux à iridectomie
Forbici per iridectomia



9,0 cm/3 1/2"
10,5 cm/4 1/4"
11,5 cm/4 1/2"

AC 450/09
AC 450/10
AC 450/11



AC 451/09
AC 451/10
AC 451/11

SCHEREN SCISSORS TIJERAS CISEAUX FORBICI

Augenscheren
Eye Scissors
Tijeras oculares
Ciseaux oculaires
Forbici oftalmologici

AA

AB

AC

AD

AE

AK

AR

KA

KM

KO

KP

XR



AC 460/11
11,5 cm/4 1/2"

Strabismusschere
Strabismus Scissors
Tijeras para estrabismo
Ciseaux à strabisme
Forbici per strabismo



AC 461/11
11,5 cm/4 1/2"

mit großen Ringen
with large bows
con anillos grandes
avec grands anneaux
con anelli grandi

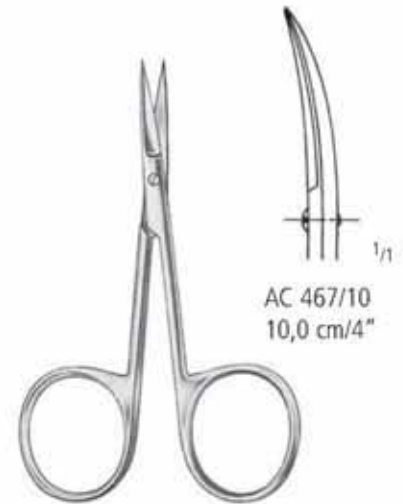

AC 467/10
10,0 cm/4"

AC 466/10
10,0 cm/4"



GRAEFE
AC 469/10
10,5 cm/4 1/4"



WILMER
AC 471/10
10,0 cm/4"

AC SCHEREN SCISSORS TIJERAS CISEAUX FORBICI

Augenscheren
Eye Scissors
Tijeras oculares
Ciseaux oculaires
Forbici oftalmologici



LA GRANGE
AC 472/11
11,5 cm/4¹/₂"



CHADWICK
AC 473/11
11,0 cm/4¹/₄"

Sehnenscheren
Tenotomy Scissors
Tijeras para tenotomía
Ciseaux à ténatomie
Forbici per tenotomia



STEVENS
10,5 cm/4¹/₈"
11,5 cm/4¹/₂"

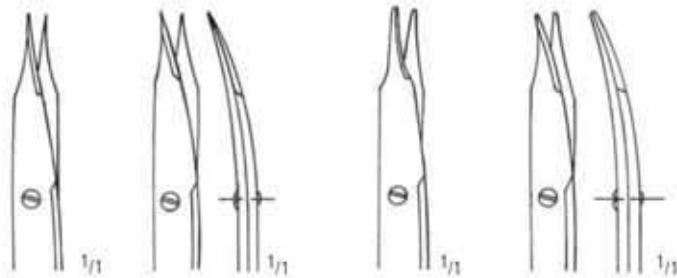

spitz
agudas
pointed
pointues
acuta

Original 11,5 cm

stumpf
romas
blunt
mousses
smussa

gerade
straight
rectas
droits
rette

gebogen
curved
curvas
courbes
curve

gerade
straight
rectas
droits
rette

gebogen
curved
curvas
courbes
curve

AC 474/10
AC 474/11

AC 475/10
AC 475/11

AC 476/10
AC 476/11

AC 477/10
AC 477/11

SCHEREN SCISSORS TIJERAS CISEAUX FORBICI

Augenscheren
Eye Scissors
Tijeras oculares
Ciseaux oculaires
Forbici oftalmologici

AA
AB
AC
AD
AE
AK
AR
KA
KM
KO
KP
XR

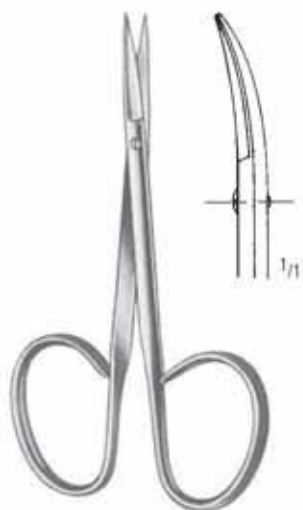

gerade
straight
rectas
droits
rette

gebogen
curved
curvas
courbes
curve

RIBBON
10,0 cm/4"

AC 488/10 AC 489/10



gerade
straight
rectas
droits
rette

gebogen
curved
curvas
courbes
curve

RIBBON
10,0 cm/4"

AC 490/10 AC 491/10

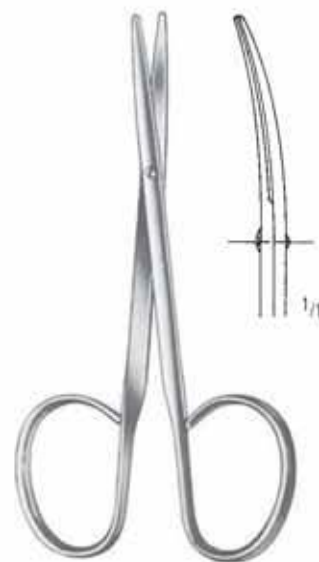

gerade
straight
rectas
droits
rette

gebogen
curved
curvas
courbes
curve

RIBBON
10,0 cm/4"

AC 492/10 AC 493/10

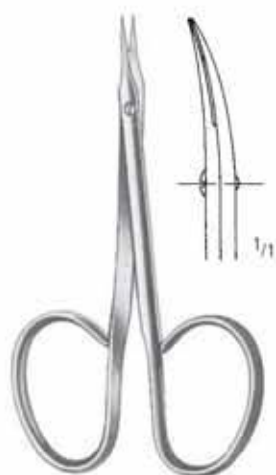

gerade
straight
rectas
droits
rette

gebogen
curved
curvas
courbes
curve

RIBBON
9,5 cm/3³/₄"

AC 494/09 AC 495/09

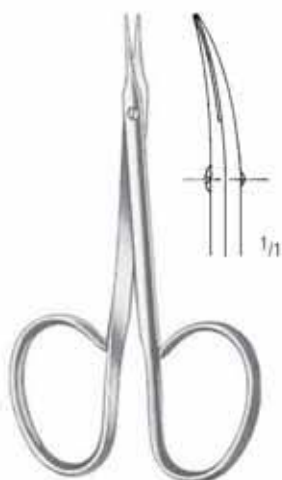

gerade
straight
rectas
droits
rette

gebogen
curved
curvas
courbes
curve

RIBBON
9,5 cm/3³/₄"

AC 496/09 AC 497/09

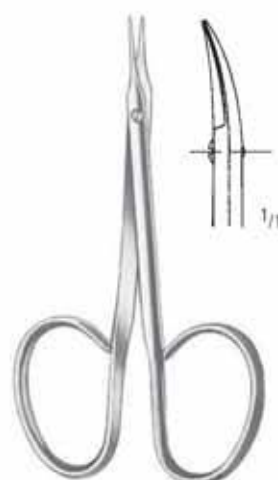

gerade
straight
rectas
droits
rette

gebogen
curved
curvas
courbes
curve

RIBBON
9,5 cm/3³/₄"

AC 498/09 AC 499/09

AC SCHEREN SCISSORS TIJERAS CISEAUX FORBICI

Ligaturscheren, Iridektomiescheren
 Ligature Scissors, Iris Scissors
 Tijeras para ligaduras, Pinzas-tijeras para iridectomía
 Ciseaux à ligatures, Ciseaux à iridectomie
 Forbici per legatura, Forbici per iridectomia



SPENCER
 9,5 cm/3¹/₂" AC 500/09
 10,5 cm/4¹/₄" AC 500/10



Fig. 1



Fig. 2



Fig. 3

NOYES
 12,0 cm/4³/₄"

Fig.1 AC 750/12
 Fig.2 AC 752/12
 Fig.3 AC 754/12



AC 760/11



AC 762/11



AC 764/11

WECKER
 11,0 cm/4¹/₂"

AC 751/12
 AC 753/12
 AC 755/12

SCHEREN SCISSORS TIJERAS CISEAUX FORBICI

Iridektomiescheren
 Iris Scissors
 Pinzas-tijeras para iridectomía
 Ciseaux à iridectomie
 Forbici per iridectomia

AA
 AB
 AC
 AD
 AE
 AK
 AR
 KA
 KM
 KO
 KP
 XR



BARRAQUER
 5,5 cm/2 1/4"

- 5 mm AC 768/05
- 7 mm AC 768/07
- 10 mm AC 768/10



CASTROVIEJO
 AC 770/00
 9,0 cm/3 1/2"



AC 770/02



AC 770/03



AC 771/09



AC 772/09

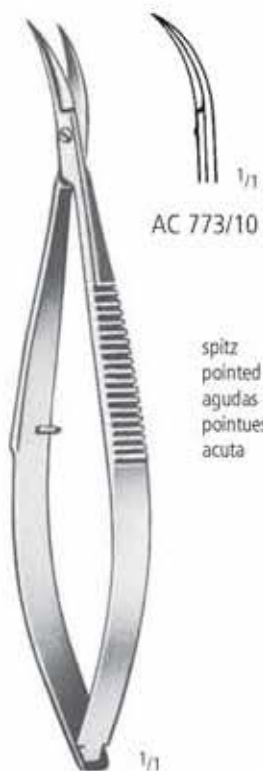

AC 773/10

spitz
 pointed
 agudas
 pointues
 acuta

CASTROVIEJO
 10,0 cm/4"

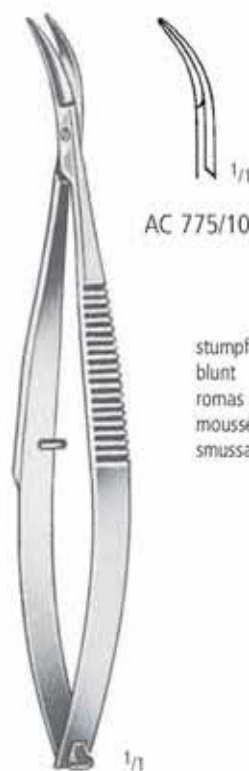

AC 775/10

stumpf
 blunt
 romas
 mousses
 smussa

CASTROVIEJO
 10,0 cm/4"

Nachstarscheren
 Secondary Cataract Scissors
 Pinzas-tijeras para catarata secundaria
 Pincés ciseaux pour le cataracte secondaire
 Pinze-forbici per cataratta secondaria



gerade
 straight
 reclus
 droīts
 rette

AC 776/01
 8,5 cm/3 1/2"



gebogen
 curved
 curvas
 courbes
 curve

AC 776/02
 8,5 cm/3 1/2"



kniegebogen
 angular
 acodadas
 coudés
 angolato

AC 776/03
 8,5 cm/3 1/2"



aufgewinkelt
 angled on flat
 acodadas hacia arriba
 coudés vers le haut
 angolato in alto

AC 776/04
 8,5 cm/3 1/2"

VANNAS MOD. TÜBINGEN



gerade
 straight
 reclus
 droīts
 rette

VANNAS
 AC 778/01
 8,0 cm/3 1/4"

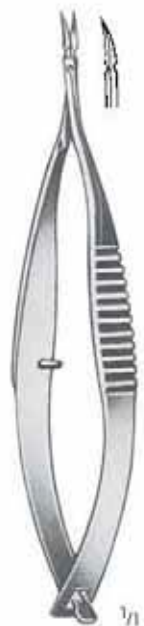

gebogen
 curved
 curvas
 courbes
 curve

VANNAS
 AC 778/02
 8,0 cm/3 1/4"



kniegebogen
 angular
 acodadas
 coudés
 angolato

VANNAS
 AC 778/03
 8,0 cm/3 1/4"

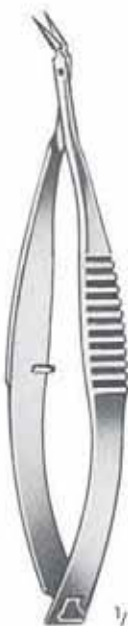

aufgewinkelt
 angled on flat
 acodadas hacia arriba
 coudés vers le haut
 angolato in alto

VANNAS
 AC 778/04
 8,0 cm/3 1/4"

SCHEREN SCISSORS TIJERAS CISEAUX FORBICI

Nachstarscheren, Sehnenscheren, Hornhautscheren
 Secondary Cataract Scissors, Tenotomy Scissors, Corneal Scissors
 Pinzas-tijeras para catarata secundaria, Pinzas-tijeras para tenotomía y córnea
 Pincès ciseaux pour le cataracte secondaire, Ciseaux à ténatomie, Ciseaux corneales
 Pinze-forbici per cataratta secondaria, Forbici per tenotomia e per cornea



GILLS-WELSH
 8,5 cm/3 1/2"



AC 779/01



AC 779/02



AC 779/03

kniegebogen
 angular
 acodadas
 coudés
 angolato



AC 779/04

aufgewinkelt
 angled on flat
 acodadas hacia arriba
 coudés vers le haut
 angolato in alto



WESTCOTT
 AC 780/11
 11,0 cm/4 1/2"



WESTCOTT
 AC 782/11
 11,0 cm/4 1/2"



CASTROVIEJO
 AC 785/01
 10,0 cm/4"



CASTROVIEJO
 AC 785/02
 10,0 cm/4"

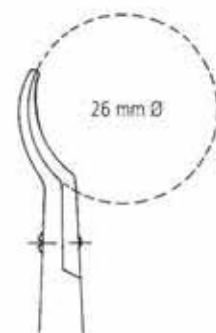

AA
 AB
 AC
 AD
 AE
 AK
 AR
 KA
 KM
 KO
 KP
 XR

AC SCHEREN SCISSORS TIJERAS CISEAUX FORBICI

Hornhautscheren
 Corneal Scissors
 Pinzas-tijeras para córnea
 Ciseaux corneales
 Forbici per cornea



CASTROVIEJO
 AC 786/01
 1/11 11,0 cm/4 1/2"



CASTROVIEJO
 AC 786/02
 1/11 11,0 cm/4 1/2"



TROUTMAN
 AC 788/01
 1/11 10,0 cm/4"



TROUTMAN
 AC 788/02
 1/11 10,0 cm/4"



KATZIN
 AC 790/01
 10,0 cm/4"



KATZIN
 AC 790/02
 10,0 cm/4"



KATZIN
 AC 791/01
 11,0 cm/4 1/2"



KATZIN
 AC 791/02
 11,0 cm/4 1/2"

SCHEREN SCISSORS TIJERAS CISEAUX FORBICI

Hornhautscheren
 Corneal Scissors
 Pinzas-tijeras para córnea
 Ciseaux corneales
 Forbici per cornea

AA

AB

AC

AD

AE

AK

AR

KA

KM

KO

KP

XR

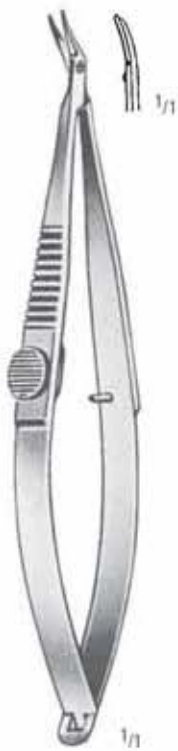

KATZIN-BARRAQUER

AC 792/01
 10,0 cm/4"



AC 792/02
 10,0 cm/4"



AC 793/00
 10,0 cm/4"



AC 793/01
 10,0 cm/4"

Hornhautscheren, Mikroscheren
 Corneal Section Scissors, Micro Scissors
 Pinzas-tijeras para córnea, Micro Tijeras
 Pincès ciseaux corneales, Micro-ciseaux
 forbici per cornea, Micro forbici



AC 794/12
 12,0 cm/4³/₄"



NOYES
 AC 795/15
 15,0 cm/6"



WESTCOTT
 AC 797/01
 11,5 cm/4¹/₂"



WESTCOTT
 AC 797/02
 11,5 cm/4¹/₂"

SCHEREN SCISSORS TIJERAS CISEAUX FORBICI

Mikroscheren
Micro Scissors
Micro Tijeras
Micro Ciseaux
Micro Forbici

- >> Alle unsere Mikroscheren werden von Fachkräften mit jahrelanger Erfahrung hergestellt. Die Endkontrolle findet unter dem Mikroskop statt. Um Ihnen ein ermüdungsfreies Arbeiten zu ermöglichen, wird dem Federdruck größte Aufmerksamkeit gewidmet.
- >> Bitte wählen Sie unter Rund- oder Flachgriffscheren.

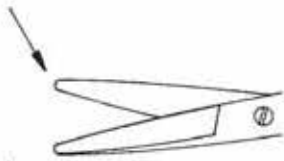

Dissection: **Gebogene Blätter, abgerundete Spitzen** ermöglichen eine gute und sichere Dissektion, ohne Nerven und Blutgefäße zu beschädigen.

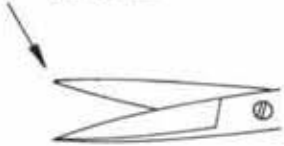

Adventitia: **Gerade Blätter, sehr scharfe Spitzen** gewährleisten präzises Anfrischen von Gefäßenden.

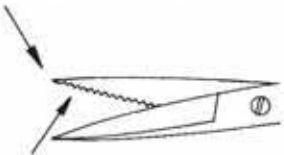

Nerve: Ein Blatt ist **fein gezahnt**, um ein Herausgleiten des Nervs zu vermeiden.

- >> All our Micro Scissors are manufactured by skilled craftsmen with many years of experience. Final inspection is carried out under a microscope. Careful attention is paid to the closing pressure of the spring handle, to ensure precise work during surgeries, without fatigue.
- >> Round or flat handle scissors according to your preference.

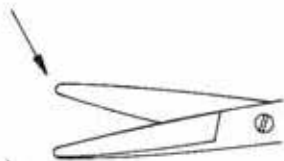

Dissection: **Curved blades, slightly rounded tips** ensure safe dissection without damage to nerves and vessels.

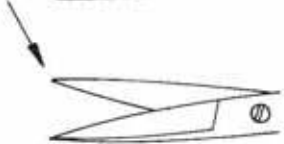

Adventitia: **Straight blades, very sharp tips** for finest trimming of vessel ends.

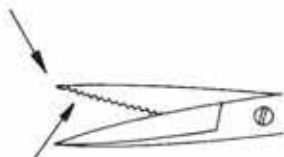

Nerve: One blade is **fine-toothed** to avoid slipping of the nerve.

AA

AB

AC

AD

AE

AK

AR

KA

KM

KO

KP

XR

AC SCHEREN SCISSORS TIJERAS CISEAUX FORBICI

Mikroscheren
Micro Scissors
Micro Tijeras
Micro Ciseaux
Micro Forbici



14,5 cm/5³/₄"



Dissection
AC 801/15



Adventitia
AC 803/15



18,0 cm/7"



Dissection
AC 801/18



Adventitia
AC 803/18

SCHEREN SCISSORS TIJERAS CISEAUX FORBICI

Mikroscheren
Micro Scissors
Micro Tijeras
Micro Ciseaux
Micro Forbici

AA

AB

AC

AD

AE

AK

AR

KA

KM

KO

KP

XR



AC 807/14
14,5 cm/5³/₄"



AC 812/18
18,0 cm/7"



AC 817/18
18,0 cm/7"

AC SCHEREN SCISSORS TIJERAS CISEAUX FORBICI

Mikroscheren
Micro Scissors
Micro Tijeras
Micro Ciseaux
Micro Forbici



11,0 cm/4¹/₃"

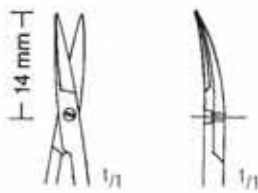

Dissection
AC 821/11

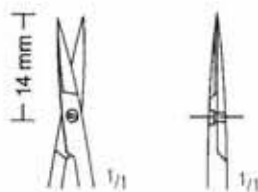

Adventitia
AC 830/11



15,0 cm/6"

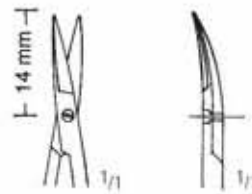

Dissection
AC 823/15

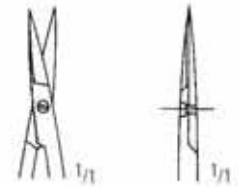

Adventitia
AC 832/15

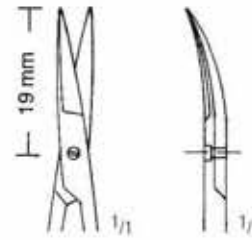

Dissection
AC 825/15

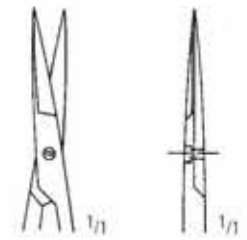

Adventitia
AC 834/15

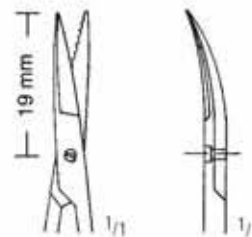

Dissection

>> Nerve >>

Adventitia
AC 836/15

SCHEREN SCISSORS TIJERAS CISEAUX FORBICI

Mikroscheren
Micro Scissors
Micro Tijeras
Micro Ciseaux
Micro Forbici

AA

AB

AC

AD

AE

AK

AR

KA

KM

KO

KP

XR



18,5 cm/7¹/₃"



AC 850/19



AC 851/19



16,0 cm/6¹/₄"
20,0 cm/8"
22,5 cm/9"



AC 860/16
AC 860/20
AC 860/22



AC 861/16
AC 861/20
AC 861/22



AC 862/16
AC 862/20
AC 862/22



AC 863/16
AC 863/20
AC 863/22



AC 864/16
AC 864/20
AC 864/22



AC 865/16
AC 865/20
AC 865/22

Mikroscheren
Micro Scissors
Micro Tijeras
Micro Ciseaux
Micro Forbici

T = TITAN



18,0 cm/7"



AC 870/01
AC 870/01 T
25°



AC 870/02
AC 870/02 T
45°



AC 870/03
AC 870/03 T
60°



AC 870/04
AC 870/04 T
90°



AC 870/05
AC 870/05 T
125°



18,0 cm/7"



18,0 cm/7"



AC 871/01
AC 871/01 T
25°



AC 871/02
AC 871/02 T
45°



AC 871/03
AC 871/0
60°



AC 871/04
AC 871/04 T
90°



AC 871/05
AC 871/05 T
125°



18,0 cm/7"

SKALPELLE
SCALPELS
BISTURIES
BISTOURIS
BISTURI

AD

nopa[®] instruments

Weitere Skalpelle finden Sie in unserem Katalog „Allgemeines Instrumentarium“ in Gruppe AD.

For further scalpels kindly refer to our catalogue "General Instruments", section AD.

Para bisturías adicionales, por favor consulte nuestro catálogo de "Instrumental de uso general", grupo AD.

Pour des bistouris supplémentaires, consultez notre catalogue „Instrumentation Generale“, section AD.

Per gli altri bisturi, consultare il nostro catalogo "Strumentazione Generale", gruppo AD.





SKALPELLE SCALPELS BISTURIES BISTOURIS BISTURI

Skalpgriffe
 Scalpel Handles
 Mangos de bisturíes
 Manches pour bistouris
 Manici per bisturi

AA

AB

AC

AD

AE

AK

AR

KA

KM

KO

KP

XR



AD 009/03
No. 3



AD 010/03
No. 3



AD 020/13
No. 3L



AD 025/07
No. 7



AD 027/07
No. 7K



AD 030/16



COLLIN
AD 040/08
No. 8

hohl
hollow
hueco
creux
vuoto

Skalpellgriffe, Skalpellslingen
 Scalpel Handles, Scalpel Blades
 Mangos de bisturías, Hojas de bisturías
 Manches pour bistouris, Lames de bistouris
 Manici per bisturi, Lame per bisturi

MINI

Verpackungseinheit 10 St.
 packing unit 10 pcs.
 unidad de venta 10 piezas
 unité à 10 pièce
 unità di vendita 10 pezzi

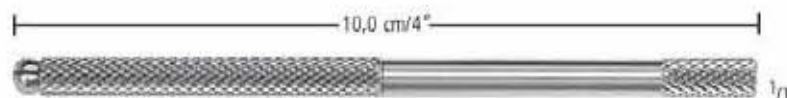

Fig. 65
 AD 065/65

steril
 sterile
 estériles
 stériles
 sterili



Fig. 67
 AD 065/67



AD 065/10



AD 065/13



AD 065/15

SKALPELLE SCALPELS BISTURIES BISTOURIS BISTURI

Skalpelliingen
Scalpel Blades
Hojas de bisturíes
Lames pour bistouris
Lame per bisturi

passend für die Griffe
for handles
para los mangos
pour les manches
per i manici

AD 009/03
AD 010/03
AD 020/13
AD 025/07
AD 027/07
AD 030/16
AD 040/08



Fig. 10
AD 075/10



Fig. 11
AD 075/11



Fig. 15
AD 075/15



Fig. 15c
AD 076/15

steril
sterile
estériles
stériles
sterili



AA

AB

AC

AD

AE

AK

AR

KA

KM

KO

KP

XR

Rasierklingen, Klingenbrecher
 Razor Blades, Blade Breakers
 Hojas de afeitár, Pinzas para romper hojas
 Lames de rasoir, Pincettes pour casser les lames
 Lamette da barba, Pinze per rompere la lamette

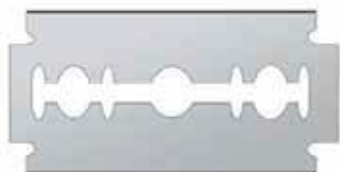

RASIERKLINGEN, VERPACKUNGSEINHEIT 10 STÜCK
 RAZOR BLADES, PACKING UNIT 10 PIECES
 HOJAS DE AFEITAR, UNIDAD DE VENTA 10 PZ
 LAMES DE RASOIR, UNITÉ À 10 PIÈCES
 LAMETTE DA BARBA, UNITÀ DI VENDITA 10 PZ

AD 540/00



TROUTMAN-CHRIS
 AD 550/09
 Ø 5,5 mm
 9,0 cm/3 1/2"



TROUTMAN-CHRIS
 AD 551/09
 Ø 5,5 mm
 9,0 cm/3 1/2"



AD 552/11
 11,0 cm/4 1/8"



CASTROVIEJO
 AD 554/13
 Ø 8 mm
 13,0 cm/5"

NAHT
SUTURE
SUTURA
SUTURE
SUTURA

AE

nopa[®] instruments

Weitere Naht-Instrumente finden Sie in unserem Katalog „Allgemeines Instrumentarium“ in Gruppe AE.

For further suture instruments kindly refer to our catalogue "General Instruments", section AE.

Para instrumentos de sutura adicionales, por favor consulte nuestro catálogo de "Instrumental de uso general", grupo AE.

Pour des instruments de suture supplémentaires, consultez notre catalogue „Instrumentation Generale“, section AE.

Per gli altri accessori di sutura, consultare il nostro catalogo "Strumentazione Generale", gruppo AE.



Nadelhalter, Nadelhalter mit Hartmetalleinsätzen
 Needle Holders, Needle Holders with Tungsten Carbide Inserts
 Porta-agujas, Porta-agujas con bocas de carburo de Tungsteno
 Porte-aiguilles, Porte-aiguilles à mors en carbure de tungstène
 Portaghi, Portaghi con placche di carburo di tungsteno



DERF
 AE 050/12
 12,5 cm/4³/₄"

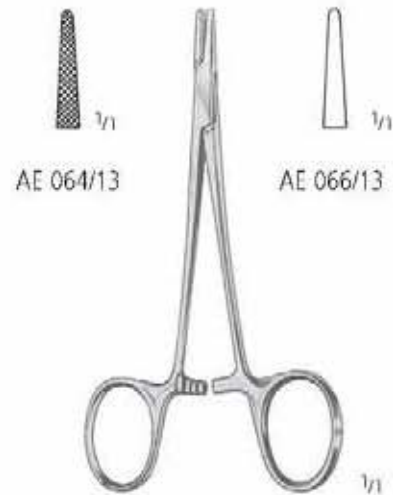

HALSEY
 13,0 cm/5"

nopa
TUC[®]



RYDER/FRENCH-EYE
 AE 430/13
 13,0 cm/5"



DERF
 AE 450/12
 12,5 cm/4³/₄"

T = TITAN

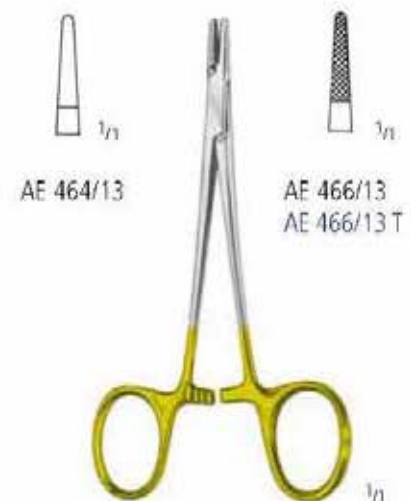

HALSEY
 13,0 cm/5"

NAHT SUTURE SUTURA SUTURE SUTURA

Nadelhalter mit Hartmetalleinsätzen
 Needle Holders with Tungsten Carbide Inserts
 Porta-agujas con bocas de carburo de tungsteno
 Porte-aiguilles à mors en carbure de tungstène
 Portaghi con placche di carburo di tungsteno

T = TITAN



AE 570/14



AE 571/14



AE 572/14
AE 572/14 T



AE 573/14

CASTROVIEJO
14,0 cm/5 1/2"

CASTROVIEJO
14,0 cm/5 1/2"



AE 576/18



AE 577/18



AE 578/18



AE 579/18

18,0 cm/7"

18,0 cm/7"

AA
AB
AC
AD
AE
AK
AR
KA
KM
KO
KP
XR

AE NAHT SUTURE SUTURA SUTURE SUTURA

Mikro-Nadelhalter mit Hartmetalleinsätzen
 Micro-Needle Holders with Tungsten Carbide inserts
 Micro-porta-agujas con bocas de carburo de Tungsteno
 Micro-porte-aiguilles à mors en carbure de tungstène
 Micro-portaghi con placche di carburo di tungsteno



JACOBSON
 21,0 cm/8¹/₄"



AE 580/01



AE 580/02
 AE 580/02 T

T = TITAN



DIETRICH

nopa
TUC[®]



AE 582/16
 16,0 cm/6¹/₄"



AE 582/18
 18,0 cm/7"



AE 582/20
 20,0 cm/8"



AE 582/23
 23,0 cm/9"



AE 582/26
 26,0 cm/10¹/₄"



KALT
 AE 584/14
 13,5 cm/5¹/₄"



CASTROVIEJO
 AE 586/13
 13,0 cm/5¹/₄"



POTTS-SMITH
 AE 588/22
 22,0 cm/8³/₄"

NAHT SUTURE SUTURA SUTURE SUTURA

Mikro-Nadelhalter mit Rundgriff
 Micro-Needle-Holders with pen-type handle
 Micro-porta-agujas con mango redondo
 Micro-porte-aiguilles à manches rondes
 Micro-portaghi con manici rotondi

AA
 AB
 AC
 AD
AE
 AK
 AR
 KA
 KM
 KO
 KP
 XR



**BARRAQUER-
TROUTMAN**
 AE 600/10
 10,0 cm/4"



**BARRAQUER-
TROUTMAN**
 AE 601/10
 10,0 cm/4"



**BARRAQUER-
TROUTMAN**
 AE 602/10
 10,0 cm/4"



**BARRAQUER-
TROUTMAN**
 AE 603/10
 10,0 cm/4"



BARRAQUER
 AE 605/11
 11,0 cm/4 1/4"



BARRAQUER
 AE 605/13
 13,0 cm/5"



BARRAQUER
 AE 605/14
 14,0 cm/5 1/2"



BARRAQUER
 AE 606/14
 14,0 cm/5 1/2"



BARRAQUER
 AE 607/14
 14,0 cm/5 1/2"

AE NAHT SUTURE SUTURA SUTURE SUTURA

Mikro-Nadelhalter mit Rundgriff
 Micro-Needle-Holders with pen-type handle
 Micro-porta-agujas con mango redondo
 Micro-porte-aiguilles à manches rondes
 Micro-portaghi con manici rotondi



TROUTMAN
 AE 609/01
 12,0 cm/4³/₄"



TROUTMAN
 AE 609/02
 12,0 cm/4³/₄"



AE 610/15

AE 611/15



AE 612/15

AE 613/15

REILL
 15,0 cm/6"

REILL
 15,0 cm/6"

NAHT SUTURE SUTURA SUTURE SUTURA

Mikro-Nadelhalter
 Micro-Needle-Holders
 Micro-porta-agujas
 Micro-porte-aiguilles
 Micro-portaghi

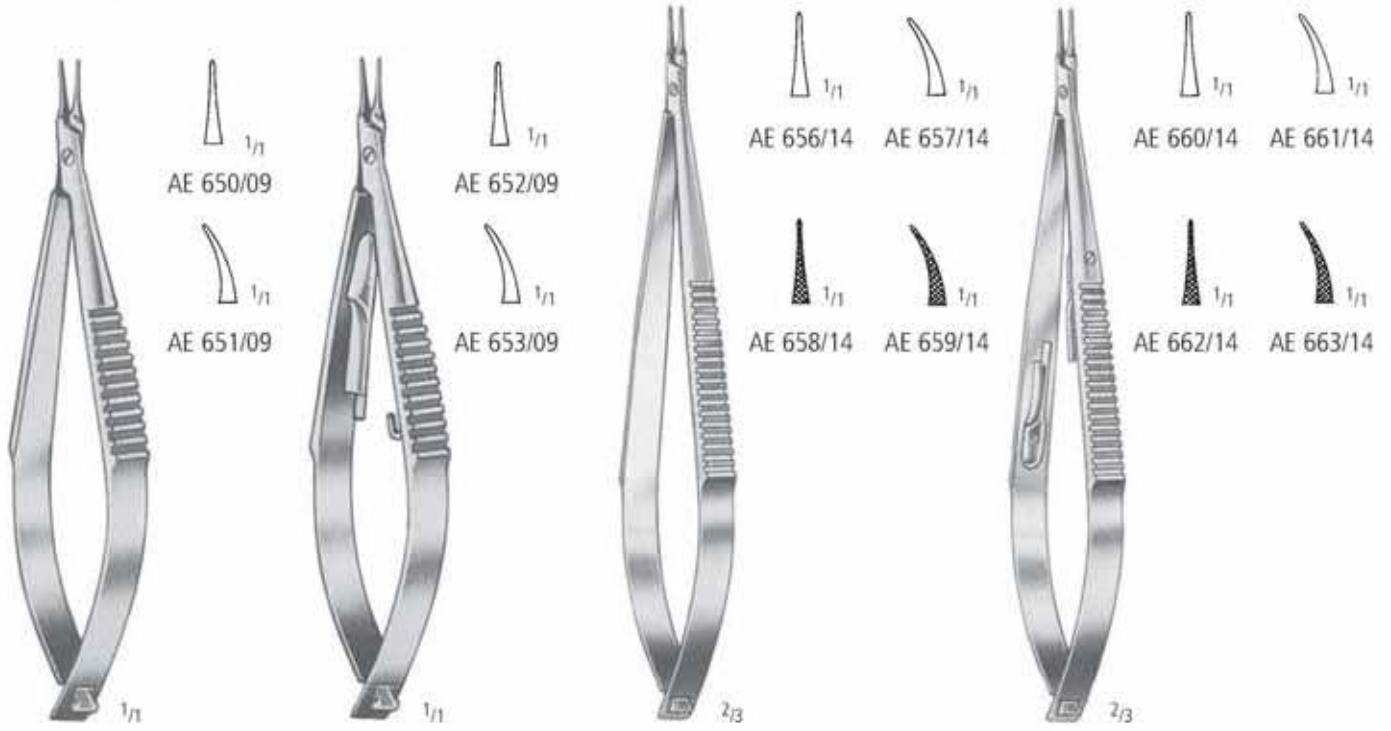

CASTROVIEJO
 9,0 cm/3 1/2"

CASTROVIEJO
 9,0 cm/3 1/2"

CASTROVIEJO
 14,0 cm/5 1/2"

CASTROVIEJO
 14,0 cm/5 1/2"

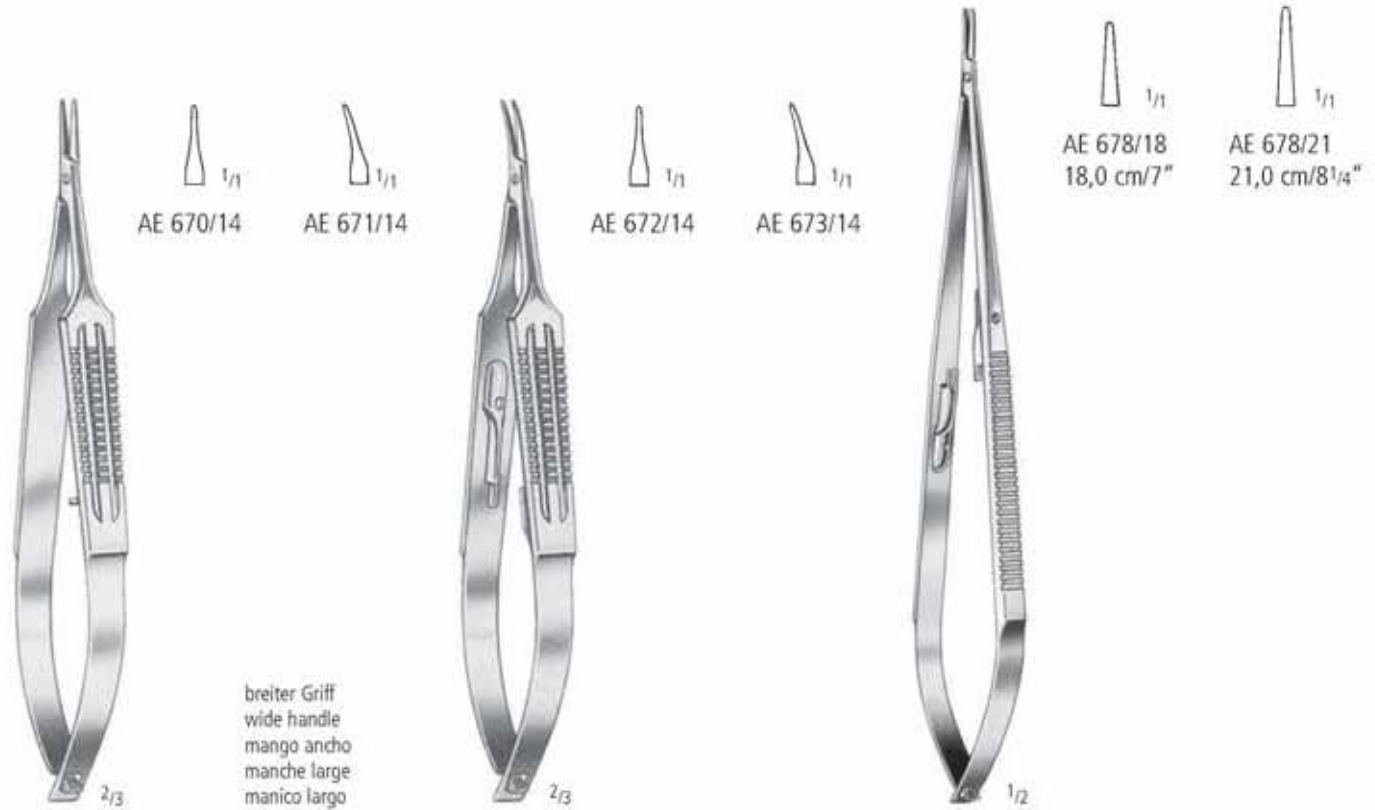

CASTROVIEJO
 14,0 cm/5 1/2"

breiter Griff
 wide handle
 mango ancho
 manche large
 manico largo

CASTROVIEJO
 14,0 cm/5 1/2"

JACOBSON

AA
 AB
 AC
 AD
AE
 AK
 AR
 KA
 KM
 KO
 KP
 XR

AE NAHT SUTURE SUTURA SUTURE SUTURA

Mikro-Nadelhalter
 Micro-Needle-Holders
 Micro-porta-agujas
 Micro-porte-aiguilles
 Micro-portaghi



PATON
 AE 684/11
 11,0 cm/4¹/₂"



PATON
 AE 685/11
 11,0 cm/4¹/₂"

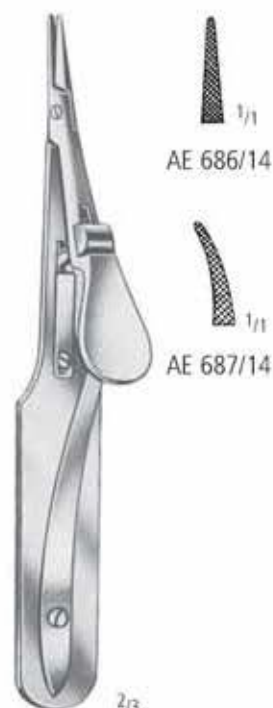

ARRUGA
 14,0 cm/5¹/₂"



KALT
 AE 688/14
 14,0 cm/5¹/₂"



KALT-ARRUGA
 AE 689/14
 14,0 cm/5¹/₂"



CASTROVIEJO-KALT
 AE 690/14
 13,5 cm/5¹/₄"



STEVENS
 AE 692/13 13,0 cm/5"
 AE 692/15 15,0 cm/6"

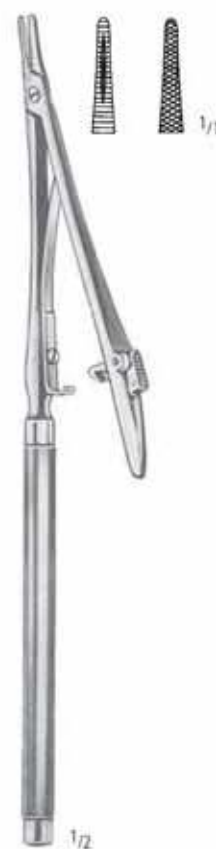

POTTS-SMITH
 AE 694/22
 22,0 cm/8³/₄"

NAHT SUTURE SUTURA SUTURE SUTURA

Mikro-Nadelhalter mit Rundgriff
 Micro-Needle-Holders with pen-type handle
 Micro-porta-agujas con mango redondo
 Micro-porte-aiguilles à manches rondes
 Micro-portaghi con manici rotondi

AA
 AB
 AC
 AD
 AE
 AK
 AR
 KA
 KM
 KO
 KP
 XR

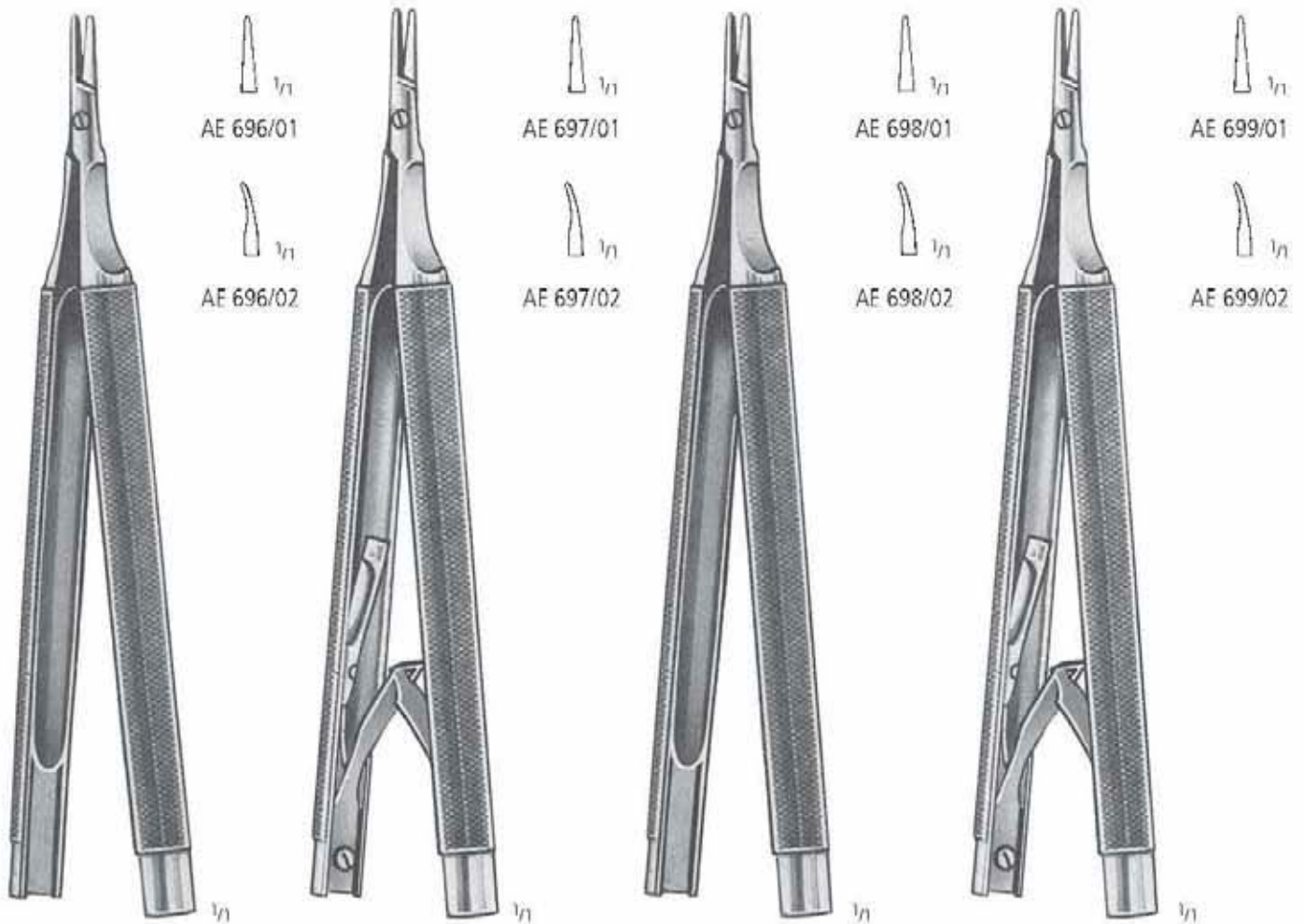

CASTROVIEJO
 13,0 cm/5 1/4"

CASTROVIEJO
 13,0 cm/5 1/4"

CASTROVIEJO
 13,0 cm/5 1/4"

CASTROVIEJO
 13,0 cm/5 1/4"

Ø Griff 8 mm
 Ø Handle 8 mm
 Ø Mango 8 mm
 Ø Manche 8 mm
 Ø Manico 8 mm

Ø Griff 10 mm
 Ø Handle 10 mm
 Ø Mango 10 mm
 Ø Manche 10 mm
 Ø Manico 10 mm

DIAGNOSTIK
DIAGNOSTICS
DIAGNOSTICO
DIAGNOSTIC
DIAGNOSTICA

AR

nopa[®] instruments

Weitere Naht-Instrumente finden Sie in unserem Katalog „Allgemeines Instrumentarium“ in Gruppe AE.

For further suture instruments kindly refer to our catalogue "General Instruments", section AE.

Para instrumentos de sutura adicionales, por favor consulte nuestro catálogo de "Instrumental de uso general", grupo AE.

Pour des instruments de suture supplémentaires, consultez notre catalogue „Instrumentation Generale“, section AE.

Per gli altri accessori di sutura, consultare il nostro catalogo "Strumentazione Generale", gruppo AE.



Messinstrumente
Measuring Instruments
Instrumentos para medidas
Instruments pour mesurer
Strumenti per misurare

AA

AB

AC

AD

AE

AK

AR

KA

KM

KO

KP

XR



1/2

AR 250/15
15,0 cm/6"



1/1

JAMESON
AR 261/08
0 - 80 mm/0.3 inch



1/1

CASTROVIEJO
AR 282/15
8,0 cm/3 1/4"

Messbereich 15 mm
measuring range 15 mm
campo de medición 15 mm
étendue de mesurage 15 mm
ampiezza di misura 15 mm



1/1

CASTROVIEJO
AR 282/20
8,0 cm/3 1/4"

Messbereich 20 mm
measuring range 20 mm
campo de medición 20 mm
étendue de mesurage 20 mm
ampiezza di misura 20 mm



1/1

CASTROVIEJO
AR 283/20
8,0 cm/3 1/4"

Messbereich 20 mm
measuring range 20 mm
campo de medición 20 mm
étendue de mesurage 20 mm
ampiezza di misura 20 mm

Ophthalmoskop
 Ophthalmoscope
 Oftalmoscopio
 Ophthalmoscope
 Oftalmoscopio



OTO- / OPHTHALMOSKOP
 AR 402/00



OPHTHALMOSKOP
 AR 420/00

OPHTHALMOLOGIE
OPHTHALMOLOGY
OFTALMOLOGIA
OPHTALMOLOGIE
OFTALMOLOGIA

KP

nopa[®] instruments



WUNDHAKEN RETRACTORS SEPARADORES ECARTEURS DIVARICATORI

Feine Wundhaken
Delicate Hooks
Ganchos
Crochets très fins
Divaricatori sottili

AA

AB

AC

AD

AE

AK

AR

KA

KM

KO

KP

XR



GILLIES
AK 020/01
18,0 cm/7"



GILLIES
AK 020/02
18,0 cm/7"



KILNER
AK 022/15
15,0 cm/6"



FRAZIER
AK 024/13
13,0 cm/5"



AK 026/01



KLEINERT-KUTZ
AK 026/02
16,0 cm/6¹/₄"



AK 026/03

AK WUNDHAKEN RETRACTORS SEPARADORES ECARTEURS DIVARICATORI

Feine Wundhaken
 Delicate Hooks
 Ganchos
 Crochets très fins
 Divaricatori sottili



AK 028/01
 16,0 cm/6 1/4"



AK 028/02
 16,0 cm/6 1/4"



AK 028/03
 16,0 cm/6 1/4"



AK 028/04
 16,0 cm/6 1/4"



O'CONNOR
 AK 030/16
 16,0 cm/6 1/4"



GRAEFE
 AK 032/01
 16,0 cm/6 1/4"



GRAEFE
 AK 032/02
 16,0 cm/6 1/4"

WUNDHAKEN RETRACTORS SEPARADORES ECARTEURS DIVARICATORI

Feine Wundhaken
Delicate Hooks
Ganchos
Crochets très fins
Divaricatori sottili

AA

AB

AC

AD

AE

AK

AR

KA

KM

KO

KP

XR



CUSHING
28,0 cm/11"



AK 034/01



AK 034/02



CUSHING
19,0 cm/7 1/2"



AK 036/01



AK 036/02



MOLDESTAD
AK 038/13
13,0 cm/5"



AK 040/05
5 mm



AK 040/07
7 mm

17,0 cm/6 3/4"



18,5 cm/7 1/3"



AK 042/10
Ø 1,0 mm



AK 042/12
Ø 1,2 mm

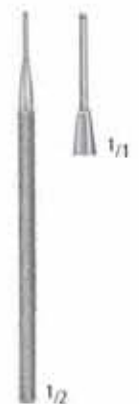

AK 044/11
11,0 cm/4 1/3"

Feine Wundhaken
Delicate Hooks
Ganchos
Crochets très fins
Divaricatori sottili

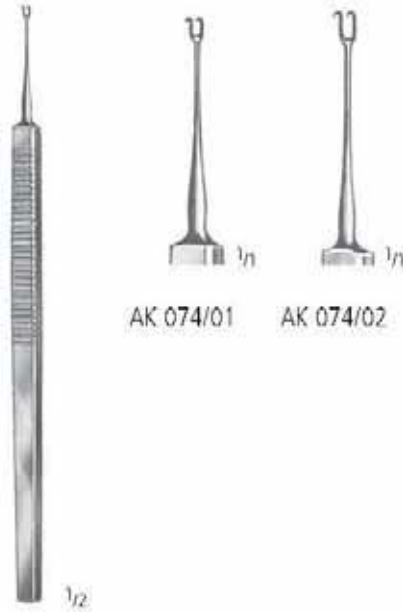

AK 074/01 AK 074/02

GUTHRIE
16,0 cm/6 $\frac{1}{4}$ "



ROLLET
AK 076/13
13,0 cm/5"

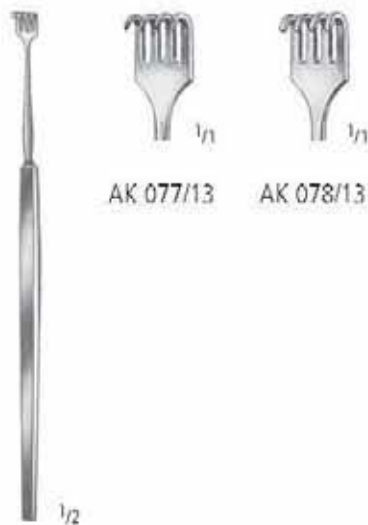

AK 077/13 AK 078/13

KNAPP
13,0 cm/5"



DESMARRES
13,0 cm/5"



AK 090/08
8 mm



AK 090/10
10 mm



AK 090/12
12 mm



AK 090/14
14 mm



AK 090/16
16 mm



AK 090/18
18 mm

Meißeln, Hammer und Hohlmeißelzangen
 Chisels, Mallet and Bone Rongeurs
 Cinceles, Martillo, Pinzas-gubias
 Ciseaux-burins, Marteau, Pincas-gouges
 Scalpelli, Martello e Pinze-sgorbie



1/2



1/2



Ø 22 mm
 200 g
 (7 oz.)

1/2

PARTSCH
 13,5 cm/5¹/₄"

- KA 433/02
- KA 433/03
- KA 433/04
- KA 433/05
- KA 433/06
- KA 433/07

mm

- 2
- 3
- 4
- 5
- 6
- 7

- KA 443/02
- KA 443/03
- KA 443/04
- KA 443/05
- KA 443/06
- KA 443/07

PARTSCH
 KA 545/20
 18,0 cm/7"



1/1

1/2

FRIEDMAN
 KA 800/14
 14,0 cm/5¹/₂"



1/1

KA 812/17

1/1

KA 813/17

LUER
 17,0 cm/6³/₄"



1/1

BÖHLER
 KA 825/01
 15,0 cm/6"

AA
 AB
 AC
 AD
 AE
 AK
 AR
 KA
 KM
 KO
 KP
 XR

Stanzen
 Punches
 Pinzas osteótomas
 Pinces ostéotomes
 Pinze osteotomi



CITELLI



KM 490/01
 1 mm



KM 490/02
 2 mm



KM 490/03
 3 mm

NASE RHINOLOGY RINOLOGIA RHINOLOGIE RINOLOGIA

Nasenspekula, Keilbeinstanzen
 Nasal Specula, Sphenoid Punches
 Espéculos nasales, Pinzas para seno esfenoidal
 Spéculum nasaux, Pincas pour sinus sphénoïdal
 Specoli nasalí, Pinze per seno sfenoidale

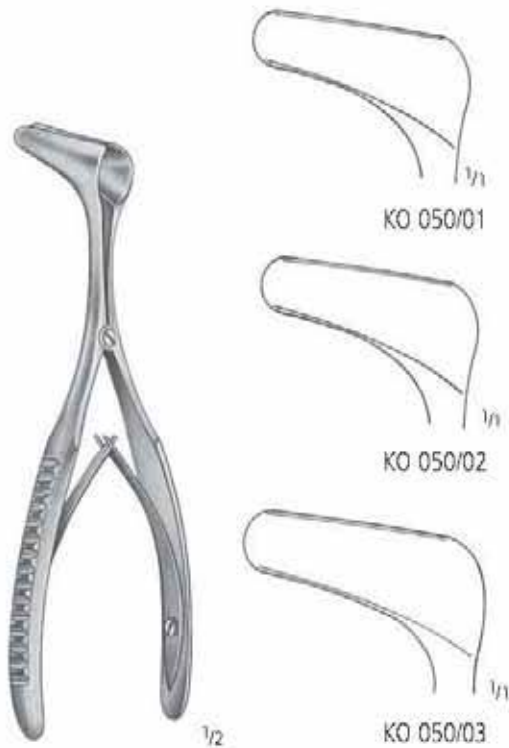

HARTMANN-HALLE
 15,0 cm/6"



KERRISON

Hohlmeißel
 Gouges
 Gubias
 Gouges
 Sgorbie



WEST
 KO 604/04
 16,0 cm/6 1/4"



WEST
 KO 605/04
 16,0 cm/6 1/4"

AA
 AB
 AC
 AD
 AE
 AK
 AR
 KA
 KM
 KP
 XR



Muskel-, Netzhautablösungs- und Schielhaken
 Musde, Retinal Detachment and Strabismus Hooks
 Ganchos de músculos, para desprendimiento de retina y para estrabismo
 Crochets musculaires, de décollement de la rétine et à strabisme
 Uncinetti per muscoli e per strabismo

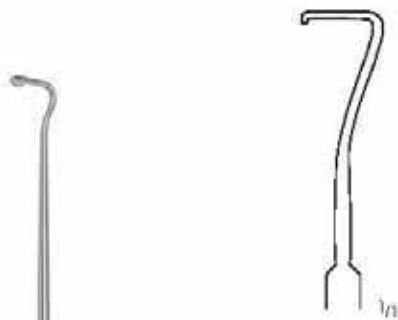

GREEN
 KP 001/13
 13,0 cm/5"

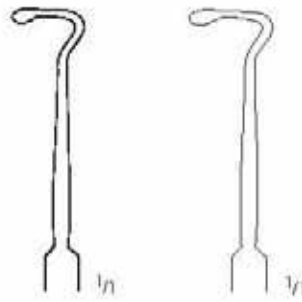

JAMESON
 KP 002/12 12,0 cm/4³/₄" KP 002/13 13,0 cm/5"



GASS
 KP 010/14
 14,0 cm/5¹/₂"



GRAEFE
 KP 015/01
 13,0 cm/5"
 Fig. 1



GRAEFE
 KP 015/02
 14,0 cm/5¹/₂"
 Fig. 2



GRAEFE
 KP 015/03
 15,0 cm/6"
 Fig. 3

Sehnenhäkchen, Fixiergabel
 Tenotomy Hook, Fixation Fork
 Gancho de tenotomía, Horquilla fijadora
 Crochet pour tenotomie, Pique de fixation
 Uncinetti de tendini e per fissazione

AA

AB

AC

AD

AE

AK

AR

KA

KM

KO

KP

XR

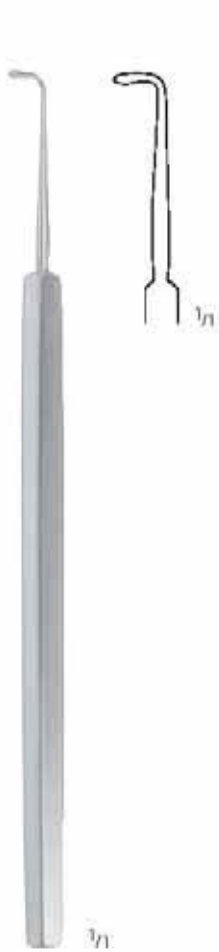

STEVENS
 KP 018/12
 12,0 cm/4³/₄"



BURCH
 KP 020/13
 13,0 cm/5"



KP 023/01
 11,0 cm/4¹/₂"

rechts
 right
 derecha
 droit
 destra



KP 023/02
 11,0 cm/4¹/₂"

links
 left
 izquierda
 gauche
 sinistra

Irishakchen
Iris Hooks
Ganchos para iris
Crochets à iris
Uncinetti per l'iride



sehr fein, scharf
very delicate, pointed
delicadísimo, afilado
très fin, coupant
fino, tagliente

BONN
KP 025/14
13,5 cm/5 1/4"



stumpf
blunt
romo
émoussé
smussato

KNOLLE
KP 026/11
11,0 cm/4 1/2"



stumpf, abgewinkelt
blunt, angled
romo, angular
émoussé, coudé
smussato, angolato

JAFFE-KNOLLE
KP 027/12
12,0 cm/4 3/4"

Irishäkchen
Iris Hooks
Ganchos para iris
Crochets à iris
Uncinetti per l'iride

AA

AB

AC

AD

AE

AK

AR

KA

KM

KO

KP

XR



1/1

TYRELL
12,0 cm/4³/₁₆"



KP 029/01

stumpf
blunt
rombo
émoussé
smussato



KP 029/02

scharf
pointed
afilado
coupant
tagliente



1/1

HIRSCHMANN
KP 030/13
12,5 cm/5"

Linsenkernwender, Linsenmanipulator
 Lens Nucleus Rotators, Lens Manipulators
 Ganchos para voltear nucleo y para posicionar cristalino
 Crochets pour tourner, Crochets manipulateurs à cristallin
 Uncinetti per rotazione di nucleo cristallino, Uncini per posizionare cristallino

TITANIUM



1/n



BECHERT
 KP 040/01
 12,0 cm/4³/₄"
 L – 7 mm

V Spitze
 V tip
 punta V
 coudé à fourche
 punta V



JAFFE-BECHERT
 KP 040/02
 12,0 cm/4³/₄"
 L – 9 mm

V Spitze
 V tip
 punta V
 coudé à fourche
 punta V



CLAYMAN
 KP 040/03
 12,5 cm/5"
 L – 10 mm

V Spitze
 V tip
 punta V
 coudé à fourche
 punta V



1/n

OSHER
 KP 050/12
 12,0 cm/4³/₄"

Linsenkernelmanipulatoren, Phakohaken
 IOL Manipulators, Phaco Splitter
 Ganchos para manipular de nucleo, Ganchos para faco
 Crochets pour manipuler le noyau, Crochets à phaco
 Uncini per posizionare cristallino, Uncini per faco

AA

AB

AC

AD

AE

AK

AR

KA

KM

KO

KP

XR

TITANIUM



DRYSDALE
 KP 051/12
 12,0 cm/4³/₄"



BUNNKATU
 KP 057/12
 12,0 cm/4³/₄"



Klinge
 blade
 hoja
 lame
 lame

60°

KP 065/60



ROSEN
 12,0 cm/4³/₄"

KP 065/90

90°

stumpfes Eck
 blunt edge
 canto romo
 coin mousse
 angolo smussato



NAGAHARA
 12,0 cm/4³/₄"

KP 067/90

Klinge
 blade
 hoja
 lame
 lame

60°

KP 067/60

90°

stumpfes Eck
 blunt edge
 canto romo
 coin mousse
 angolo smussato

IDL Positionshäkchen
 Lens Manipulators
 Ganchos para posicionar cristalino
 Crochets manipulateurs à cristallin
 Uncini per posizionare cristallino

TITANIUM



1

1/1

KP 070/20
 KP 070/25

SINSKEY
 12,0 cm/4³/₄"

Ø 0,20 mm
 Ø 0,25 mm



1/1

KP 071/20
 KP 071/25

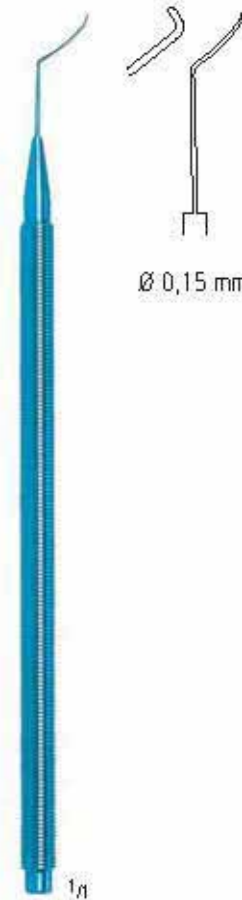

1/1

LEWICKY
 KP 075/15
 12,0 cm/4³/₄"

Ø 0,15 mm

IDL Positionshäkchen
 Lens Manipulators
 Ganchos para posicionar cristalino
 Crochets manipulateurs à cristallin
 Uncini per posizionare cristallino

AA

AB

AC

AD

AE

AK

AR

KA

KM

KO

KP

XR

TITANIUM

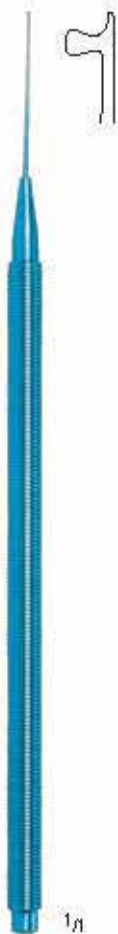

1/1

LESTER
 KP 077/01
 12,0 cm/4³/₄"



1/1

KP 077/02
 12,0 cm/4³/₄"



LESTER

KP 077/03
 12,0 cm/4³/₄"



gewölbt
 vaulted
 abovedado
 cintré
 convesso

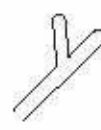

JAFFE-MALTMANN

KP 081/12
 12,0 cm/4³/₄"



1/1

RENTSCH
 KP 085/12
 12,0 cm/4³/₄"

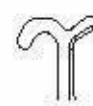

Tränenkanalsonden
 Lacrimal Probes
 Sondas exploradoras para canal lacrimal
 Sondes exploratrices pour le canal lacrymal
 Sonde esploratrici per canale lacrimale

AA

AB

AC

AD

AE

AK

AR

KA

KM

KO

KP

XR



geknöpft
 pointed
 con botón
 boutoné
 bottonuto

- KP 114/00
- KP 115/00
- KP 115/01
- KP 115/12
- KP 115/23
- KP 115/34
- KP 115/45
- KP 115/56
- KP 115/67
- KP 115/78

Fig.	mm Ø
0000/00	0,4 / 0,6
00/0	0,7 / 0,8
0/1	0,8 / 0,9
1/2	0,9 / 1,1
2/3	1,1 / 1,3
3/4	1,3 / 1,4
4/5	1,4 / 1,5
5/6	1,5 / 1,6
6/7	1,6 / 1,8
7/8	1,8 / 1,9

BOWMAN
 12,5 cm/5"

aus Silber
 Sterling silver
 de plata pura
 en argent pur
 in argento puro



zylindrisch
 cylindrical
 cilindrica
 cylindrique
 cilindrico

- KP 116/00
- KP 117/00
- KP 117/01
- KP 117/12
- KP 117/23
- KP 117/34
- KP 117/45
- KP 117/56
- KP 117/67
- KP 117/78



BOWMAN
 12,5 cm/5"

Tränenkanaldilatatoren
 Lacrimal Dilators
 Dilatadoras para canal lacrimal
 Dilatateurs pour le canal lacrymal
 Dilatatori per canale lacrimale



KP 120/01
Fig. 1



KP 120/02
Fig. 2

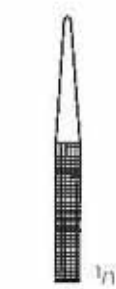

KP 120/03
Fig. 3



WILDER
10 cm/4"



MULDOON
KP 121/11
10,5 cm/4 1/4"



RUEDEMANN
KP 122/07
7 cm/2 3/4"

Tränenkanaldilatatoren, Trabekularsonden, Pigtail Sonde
 Lacrimal Dilators, Trabecular Probes, Pigtail Probe
 Dilatadoras para canal lacrimal, Sondas trabeculares, Sonda pigtail
 Dilatateurs pour le canal lacrymal, Sondes trabéculaires, Sonde spiralee
 Dilatatori per canale lacrimale, Sonde trabecolari, Sonda a pigtail



CASTROVIEJO
 KP 123/14
 14 cm/5 1/2"



KP 130/01

rechts
 right
 derecha
 droit
 destra



HARMS
 4,5 cm/1 3/4"

KP 130/02

links
 left
 izquierda
 gauche
 sinistra



WORST
 KP 135/14
 13,5 cm/5 1/4"

AA

AB

AC

AD

AE

AK

AR

KA

KM

KO

KP

XR

Lidsperre
Eye Specula
Blefarostatos
Blépharostats
Blefarostati

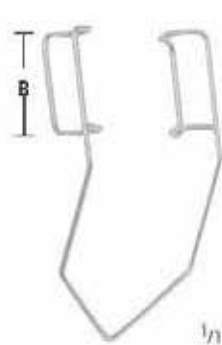

BARRAQUER-COLIBRI

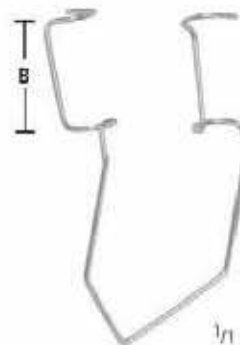

KRATZ-BARRAQUER



BARRAQUER

geschlossene Valven
solid blades
hojas sólidas
cullers plaines
valve massicce

Frühgeborene
Premature Infant
Parlo prematuro
Accouchement prématuré
Parto prematuro

B
5 mm KP 150/05
3,0 cm/1 1/4"

B

B

Kind
Child
Niños
Enfants
Bambini

10 mm KP 150/10
3,0 cm/1 1/4"

10 mm KP 151/10
4,0 cm/1 1/2"

10 mm KP 152/10
4,0 cm/1 1/2"

Erwachsene
Adults
Adultos
Adultes
Adulti

15 mm KP 150/15
4,0 cm/1 1/2"

14 mm KP 151/14
4,5 cm/1 3/4"

15 mm KP 152/15
4,0 cm/1 1/2"



BARRAQUER PHAKO
KP 154/04
4,0 cm/1 1/2"



BOWMAN
KP 160/07
7,0 cm/2 3/4"



CORCELLE
KP 161/05
5,0 cm/ 2"
B = 8 mm



WILLIAMS
KP 162/09
9,0 cm/3 1/2"
B = 14 mm

Lidsperrer
Eye Specula
Blefarostatos
Blépharostats
Blefarostati

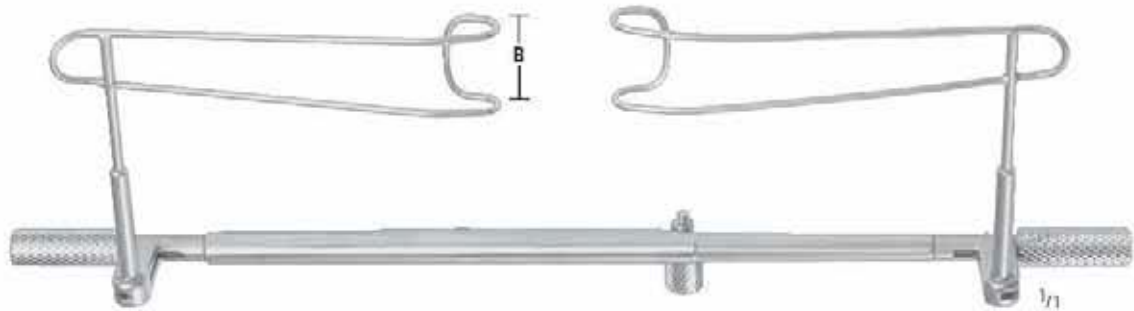

SCHOTT
15,0 cm/6"

Kind
Child
Niños
Enfants
Bambini

B
12 mm KP 170/12

Erwachsene
Adults
Adultos
Adultes
Adulti

B
15 mm KP 170/15



CASTROVIEJO
KP 175/09
9,0 cm/3 1/2"
B = 16 mm



MAUMENEE-PARK
KP 176/09
8,5 cm/3 1/4"



MAUMENEE-PARK
KP 177/09
8,5 cm/3 1/4"

AA
AB
AC
AD
AE
AK
AR
KA
KM
KO
KP
XR

Lidsperrer
Eye Specula
Blefarostatos
Blépharostats
Blefarostati



PLEY
KP 185/07
6,5 cm/2 1/2"



LANCASTER
KP 186/08
8,0 cm/3 1/4"



LESTER-BURCH
KP 187/08
8,0 cm/3 1/4"



COOK

	B	
Kind	10 mm	KP 200/10
Child		4,0 cm/1 1/2"
Niños		
Enfants		
Bambini		
Erwachsene	15 mm	KP 200/15
Adults		5,0 cm/ 2"
Adultos		
Adultes		
Adulti		



SAUER

	B	
Kind	8 mm	KP 205/08
Child		3,0 cm/1 1/4"
Niños		
Enfants		
Bambini		

Lidsperrer
Eye Specula
Blefarostatos
Blépharostats
Blefarostati



V-förmig
V-shaped
forma V
forme V
forme V

LIEBERMAN
KP 210/01
8,0 cm/3 1/4"
B = 15 mm



K-förmig
K-shaped
forma K
forme K
forme K

LIEBERMAN
KP 210/02
8,0 cm/3 1/4"
B = 15 mm



LIEBERMAN
KP 211/08
8,0 cm/3 1/4"
B = 15 mm



LIEBERMAN
KP 212/08
8,0 cm/3 1/4"
B = 15 mm

AA

AB

AC

AD

AE

AK

AR

KA

KM

KO

KP

XR

Tränensackspreizer, Lidplatte
 Lacrimal Sac Retractors, Lid Plate
 Separadores para saco lacrimal, Placa para párpados
 Ecarteurs à sac lacrymal, Plaque à paupières
 Divaricatore per sacco lacrimale, Elevatori per palpebre



STEVENSON
 KP 230/08
 7,5 cm/3"



AGRICOLA
 KP 232/05
 4,5 cm/1 3/4"



JAFFE
 4,0 cm/1 1/2"

B
 10 mm KP 245/10
 Kind
 Child
 Niños
 Enfants
 Bambini

B
 15 mm KP 245/15
 Erwachsene
 Adults
 Adultos
 Adultes
 Adulti

Paar
 Pair
 Par
 Paire
 Paio



JAEGER
 KP 248/11
 11,0 cm/4 1/2"

Orbitalretractoren und -spatel, Wundlöffel
 Orbital Retractors and Spatulas, Protector
 Separadores y espátulas orbitales, Protector
 Ecarteurs et spatules à orbite, Protecteur
 Divaricatori orbitale, Spatole per orbita, Protettore

AA

AB

AC

AD

AE

AK

AR

KA

KM

KO

KP

XR

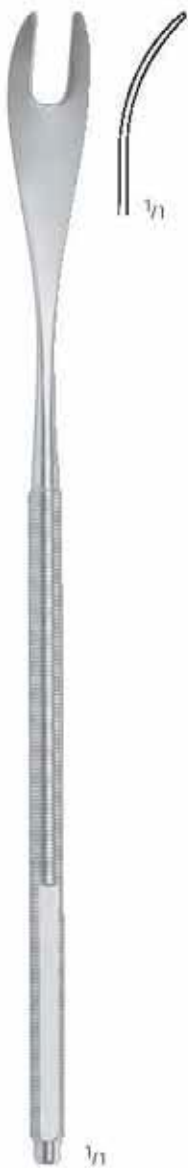

SCHEPENS
 KP 260/16
 15,5 cm/6 1/4"



SAUTTER
 KP 261/15
 15,0 cm/6"



ARRUGA
 KP 262/13
 13,0 cm/5"



LASIK
 KP 270/10
 10,0 cm/4"

Depressor, Sklera Marker
 Depressors, Scleral Markers
 Depresores, Marcadores de esclerótica
 Dépresseurs, Marqueur scléral
 Depressore, Marcadori sclerali



SCHOCKET
 KP 280/14
 14,0 cm/5 1/2"



GASS
 KP 285/05
 4,5 cm/1 3/4"
 Ø 1,5 mm



SCHEPENS
 4,0 cm/1 1/2"

KP 290/08
 Fig. 8

klein
 small
 pequeño
 petit
 piccolo

KP 290/10
 Fig. 10

medium
 medium
 medio
 moyen
 medio

KP 290/12
 Fig. 12

groß
 large
 grande
 grand
 grande

Hornhautmesser und -schaber, Diszisionmesser
 Corneal Knives and Scarifiers, Discission Knives
 Cuchillos y Rescadores para la córnea, Cuchillos para discisión
 Kératomes, Grattoirs cornéés, Couteaux à discision
 Coltelli per cornea, Raschiatoi corneali, Coltelli per discissione

AA
AB
AC
AD
AE
AK
AR
KA
KM
KO
KP
XR



SATO
 KP 300/12
 12,0 cm/ 4³/₄"
 5 mm



GILL
 KP 302/13
 12,5 cm/4¹/₂"
 3 mm

gerade
 straight
 recto
 droit
 retto



KP 303/12
 11,5 cm/ 5"
 3 mm

gebogen
 curved
 curvas
 courbes
 curve



TOOK
 KP 305/11
 11,0 cm/ 4¹/₄"
 3 x 18 mm



KUHNT
 KP 309/11
 11,0 cm/ 4¹/₄"
 3 x 5 mm



ZIEGLER
 11,0 cm/ 4¹/₄"
 KP 310/03
 3 mm



KP 310/05
 5 mm



WHEELER
 KP 312/11
 11,0 cm/ 4¹/₄"
 1 x 18 mm

Star-, Sklera-, Goniotomiemesser
 Cataract, Sclera and Goniotomy Knives
 Cuchillos para catarata, para esclerótica, para goniotomía
 Couteaux à cataracte, pour la sclère, à goniotomie
 Coltelli per cataratta, sclerali e per goniotomia



1/1

GRAEFE



1/1

KP 320/20
 12,0 cm/ 4³/₄"
 20 mm



1/1

KP 320/25
 12,5 cm/ 5"
 25 mm



1/1

BONN



1/1

KP 325/05
 12,5 cm/ 5"
 5 mm



1/1

KP 325/06
 12,5 cm/ 5"
 6 mm



1/1

BARKAN
 KP 330/12
 12,0 cm/ 4³/₄"
 2 mm



1/1

Luftlanze, Keratoplastikmesser, Zystotome
 Keratome, Keratoplasty Knives, Cystotomes
 Querátomo, Cuchillos para queratoplástica, Quístótomos
 Couteaux lancéolaires, Couteaux pour kératoplastie, Cystotomes
 Coltelli lanceolan, Coltelli per cheratoplastica, Cistotomi

AA

AB

AC

AD

AE

AK

AR

KA

KM

KO

KP

XR

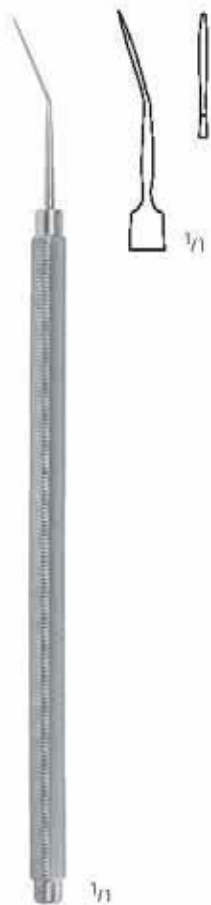

MOD. HAMBURG
 KP 335/12
 12,0 cm/ 4³/₄"



PAUFIQUE
 KP 340/11
 10,5 cm/ 4¹/₄"

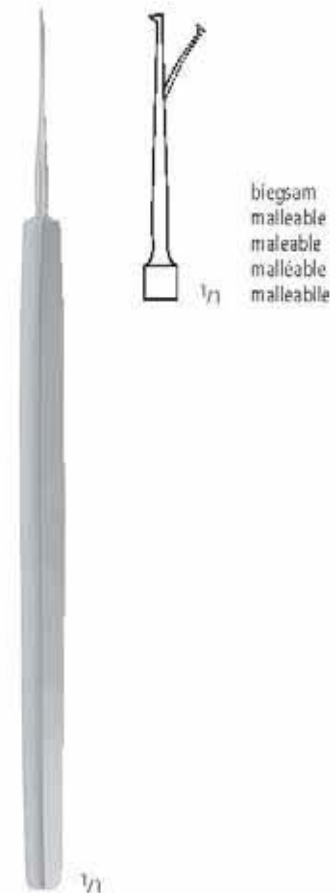

GRAEFE
 KP 346/13
 12,5 cm/ 5"

biegsam
 malleable
 maleable
 malléable
 malleabile

Fremdkörpernadeln, -hohlmeißel und -meißel
 Foreign Body Needles, Gouges and Spuds
 Agujas, Gubias y Cinceles para cuerpos extraños
 Aiguilles, Gouges et Ciseaux-burins à corps étrangers
 Aghi, Sigorbie e Scalpelli per corpi estranei



KP 350/12

umschraubbar
 reversible
 reversible
 réversible
 rivoltabile



KP 350/13

umschraubbar
 reversible
 reversible
 réversible
 rivoltabile



1/2



KP 351/01



KP 351/02



KP 351/03

Fremdkörpernadeln und -meißel
 Foreign Body Needles and Spuds
 Agujas y Cinceles para cuerpos extraños
 Aiguilles et Ciseaux-burins à corps étrangers
 Aghi e Scalpelli per corpi estranei

AA

AB

AC

AD

AE

AK

AR

KA

KM

KO

KP

XR



KP 354/12
 12,0 cm/ 4³/₄"



KP 355/12
 12,0 cm/ 4³/₄"



DAVIS
 KP 360/12
 12,0 cm/ 4³/₄"

scharf, rund
 sharp, round
 afilado, redondo
 coupant, rond
 tagliente, rotondo



ELLIS
 KP 361/12
 11,5 cm/4¹/₂"

gebogen, rund
 curved, round
 curvado, redondo
 courbe, rond
 curvo, rotondo



FRANCIS
 KP 363/12
 12,0 cm/ 4³/₄"



GOLF-CLUB
 KP 364/12
 11,5 cm/4¹/₂"

Fremdkörpernadeln, -hohlmeißeln und -meißeln, Augenmagnet mit Fremdkörperschlinge
 Foreign Body Needles, Gouges and Spuds, Magnetic Eye Probe with Foreign Body Loop
 Agujas, Gubias y Cinceles para cuerpos extraños, Imán oftálmico con asa para cuerpos extraños
 Aiguilles, Gouges et Ciseaux-burins à corps étrangers, Aimant oculaire avec anse pour corps étrangers
 Aghi, Sgorbie e Scalpelli per corpi estranei, Calamita per occhi con ansa per corpi estranei

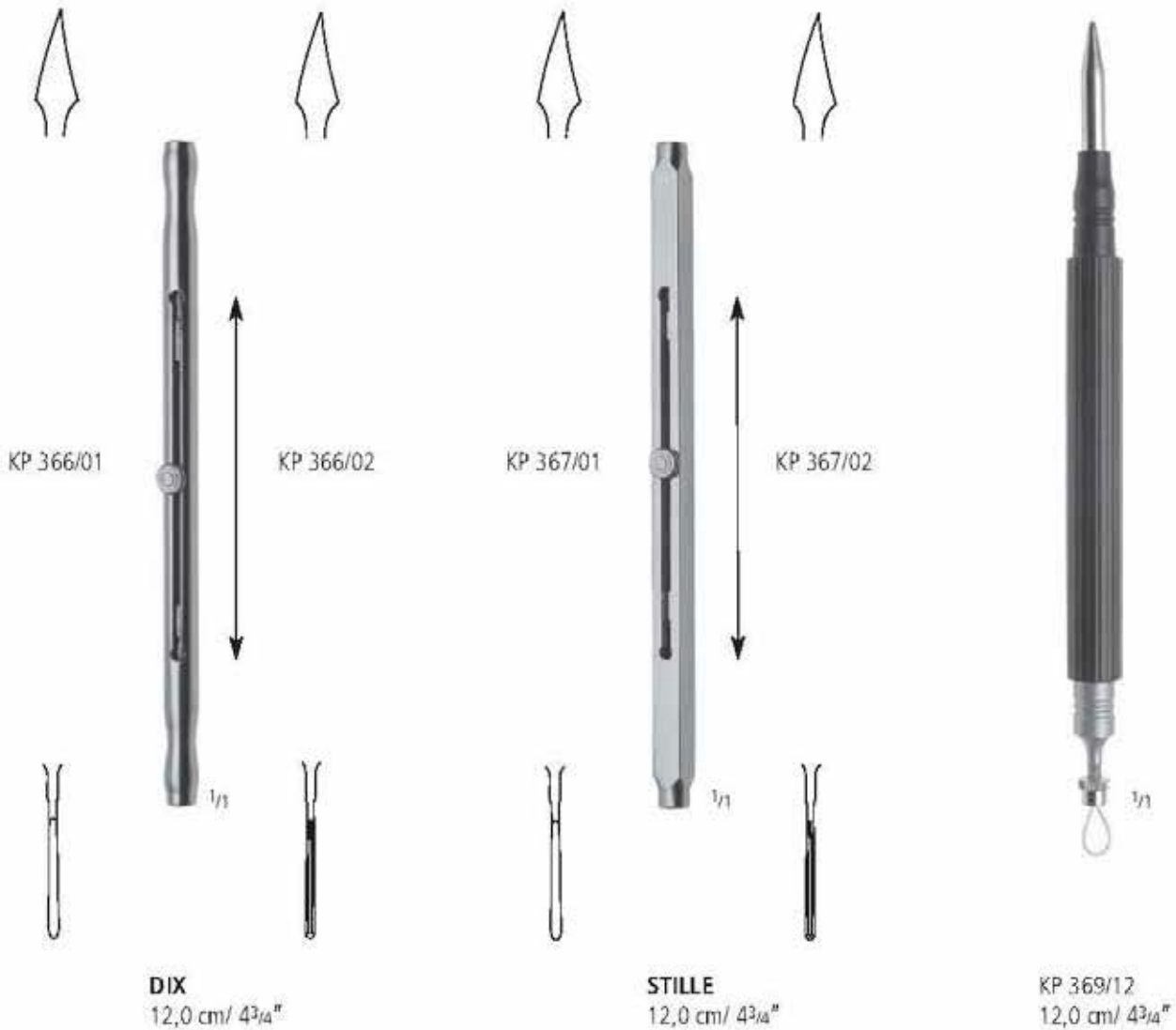

Diamantmesser
 Diamond Knives
 Bisturís de diamante
 Couteaux de diamant
 Coltelli di diamanti

AA

AB

AC

AD

AE

AK

AR

KA

KM

KO

KP

XR

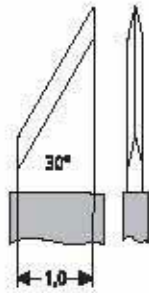

KP 370/01

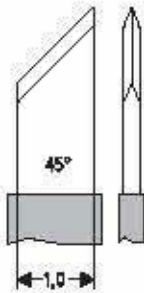

KP 370/02

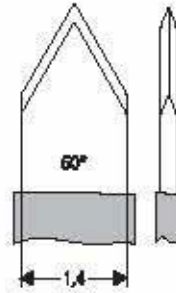

KP 370/03



1/1

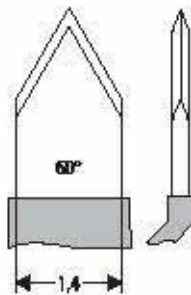

KP 370/04

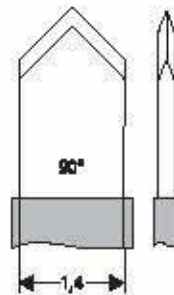

KP 370/05

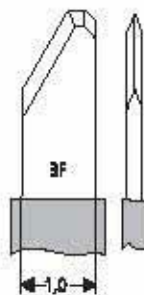

KP 371/01

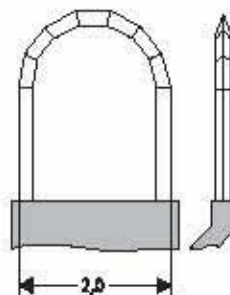

KP 371/02

Diamantmesser
 Diamond Knives
 Bisturís de diamante
 Couteaux de diamant
 Coltelli di diamanti

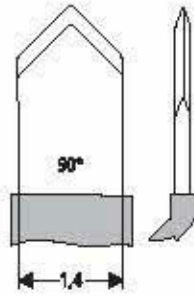

KP 373/01

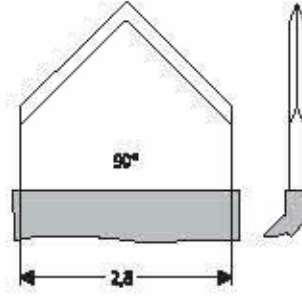

KP 373/02

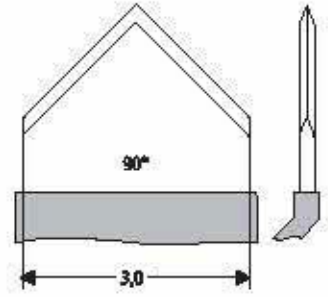

KP 373/03



1/1

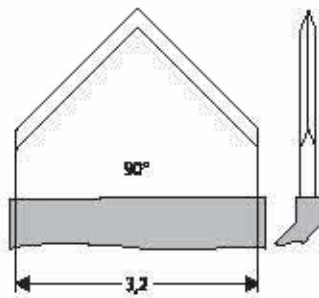

KP 373/04

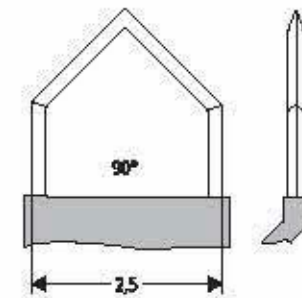

KP 373/05

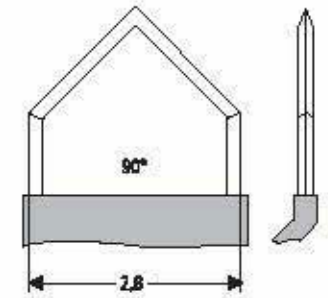

KP 373/06

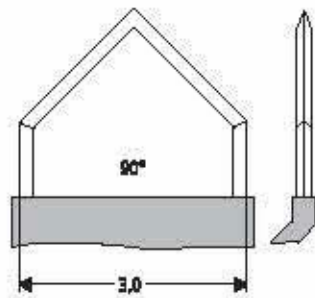

KP 373/07

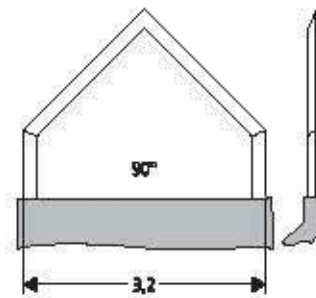

KP 373/08

Diamantmesser
 Diamond Knives
 Bisturís de diamante
 Couteaux de diamant
 Coltelli di diamanti

AA

AB

AC

AD

AE

AK

AR

KA

KM

KO

KP

XR



1/1

mit Mikrometer
 with micrometer
 con micròmetro
 avec micromètre
 con micrometro

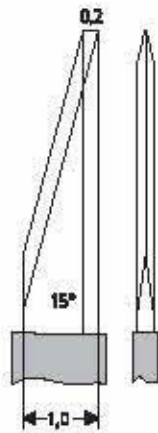

KP 375/01

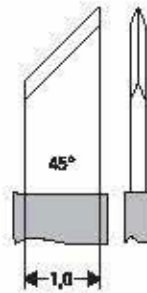

KP 375/02

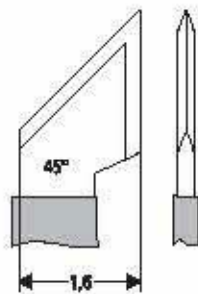

KP 375/03



1/1

7 Stufen:
 7 steps:
 7 escalones:
 7 étages:
 7 gradi:

0 / 0,3 / 0,4 / 0,5 / 0,6 / 0,8 / 1,0 / 2,5 mm

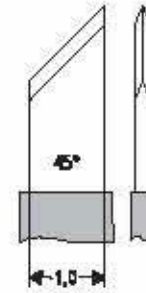

KP 376/01

Vitrektomiescheren
 Vitrectomy Scissors
 Tijeras de vitrectomía
 Ciseaux pour vitrectomie
 Forbici per vitrectomia



KP 390/00
0°



KP 390/30
30°



60° KP 390/60
90° KP 390/90

ohne Spülung
 without irrigation
 sin irrigación
 sans irrigation
 senza irrigazione

mit Spülung
 with irrigation
 con irrigación
 avec irrigation
 con irrigazione

KP 391/00
0°

KP 391/30
30°

Vitrektomiefasszangen
 Vitrectomy Grasping Forceps
 Pinzas de vitrectomía
 Pincas pour vitrectomie
 Pinze per vitrectomia

AA
 AB
 AC
 AD
 AE
 AK
 AR
 KA
 KM
 KO
 KP
 KR



KP 394/00



KP 395/01



KP 395/02



KP 395/03



0,30 mm
 0,44 mm

KP 396/30
 KP 396/44



KP 397/45
 45°



KP 397/90
 90°

Exenterations- und Enukleationslöffel
 Exenteration- and Enucleation Spoons
 Cucharas para exenteración y para enucleación
 Cuillers à éviscération et à énucléation
 Cucchiari da enucleazione



BUNGE



KP 400/01
14,0 cm/5 1/2"



KP 400/02
14,0 cm/5 1/2"



WELLS



KP 405/14
14,0 cm/5 1/2"

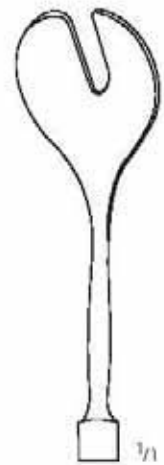

KP 405/15
15,0 cm/6"

Starlöffel, Chalazionlöffel
 Corneal Button Transfer Spoon, Chalazion Curettes
 Cucharas para transferir la córnea, Cucharillas para chalazión
 Cuillers pour transférer la cornée, Cuillères à chalazion
 Anse per cristallino, Cucchiari per calazio

AA

AB

AC

AD

AE

AK

AR

KA

KM

KO

KP

XR



KNAPP
 KP 410/14
 13,5 cm/5 1/4"

für Hornhauttransfer
 for corneal button transfer
 para transferir la córnea
 pour transférer la cornée
 per trasferire la cornea

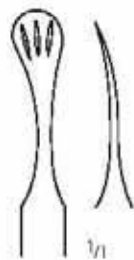

CASTROVIEJO
 KP 411/12
 12,0 cm/4 3/4"



MEYHOEFER
 13,0 cm/5"



KP 415/10
 Ø 1,0 mm



KP 415/15
 Ø 1,5 mm



KP 415/18
 Ø 1,8 mm



KP 415/20
 Ø 2,0 mm



KP 415/25
 Ø 2,5 mm



KP 415/30
 Ø 3,0 mm



KP 415/35
 Ø 3,5 mm

Chalazionlöffel, Starlöffel, Starschlingen
 Chalazion Curettes, Cataract Spoons, Lens Scoops
 Cucharillas para chalazión y para catarata, Asas para catarata
 Cuillers à chalazion et à cataracte, Anses à cataracte
 Cucchiari per calazio, Cucchiari per cataratta, Anse per cataratta

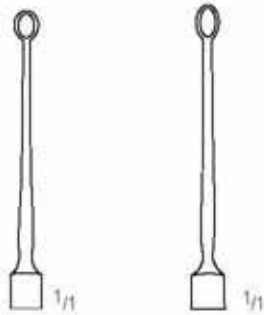

HEBRA
 13,0 cm/5"
 KP 417/20 KP 417/25
 Ø 2,0 mm Ø 2,5 mm



GRAEFE
 KP 425/14
 13,5 cm/5¹/₄"



DAVIEL
 KP 427/12
 12,0 cm/4³/₄"
 3 x 14 mm



SNELLEN
 KP 440/13
 13,0 cm/5"



ARLT
 KP 442/13
 13,0 cm/5"



LEWIS
 13,0 cm/5"
 KP 443/01 KP 443/02
 4,0 mm 4,7 mm



NEW ORLEANS
 KP 450/13
 13,0 cm/5"

Positionsspatel, Linsenkermspatel
 Lens Spatulas, Nucleus Spatulas
 Espátulas para manipular, Espátulas para núcleo cristalino
 Spatules pour manipuler, Spatules pour noyau
 Spatole per manipolare, Spatole per nucleo cristallino

AA
AB
AC
AD
AE
AK
AR
KA
KM
KO
KP
XR



JAFFE
 KP 470/12
 12,0 cm/ 4³/₄"
 0,5 mm



OBSTBAUM
 KP 471/12
 12,0 cm/ 4³/₄"
 0,25 mm



HIRSCHMANN
 KP 472/13
 12,5 cm/5"



MOD. DORTMUND
 KP 478/12
 12,0 cm/ 4³/₄"
 0,6 x 12 mm

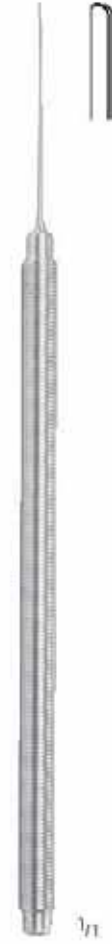

KNOLLE
 KP 480/13
 12,5 cm/5"

TITANIUM



LIPPMAN
 KP 481/12
 12,0 cm/ 4³/₄"



Zyklodialysespatel
 Cycdodialysis Spatulas
 Espátulas para ciclodialísis
 Spatules à cycdialyse
 Spatole per ciclodialisi



CASTROVIEJO-BARRAQUER
 KP 485/11
 11,0 cm/4 1/2"
 0,5 x 10 mm

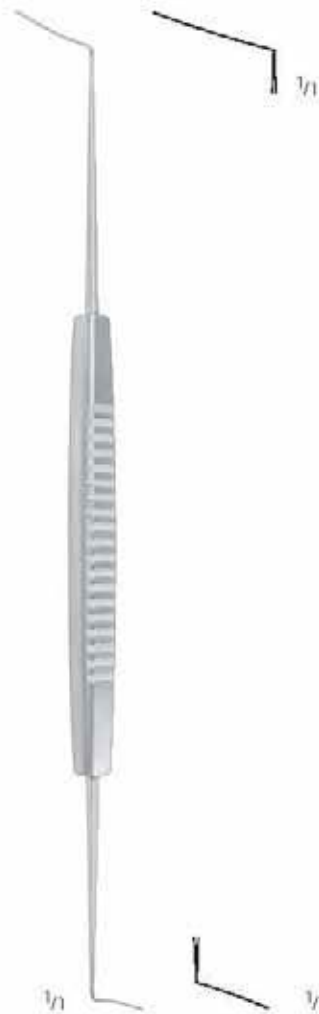

CASTROVIEJO
 KP 487/14
 13,5 cm/5 1/4"
 0,5 x 10/16 mm

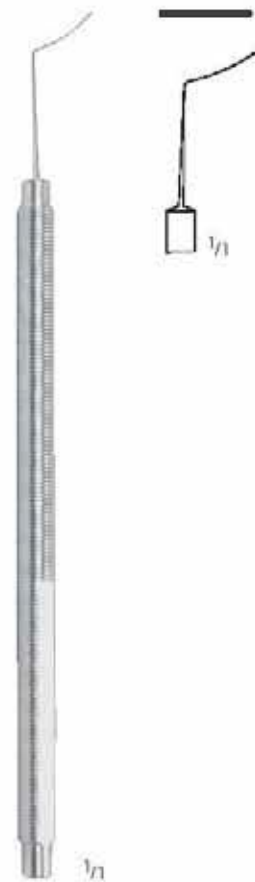

BARRAQUER-FINO
 KP 489/12
 11,5 cm/4 1/2"
 0,25 x 12 mm

Irisspatel
Iris Spatulas
Espátulas para iris
Spatules à iris
Spatole per l'iride

AA

AB

AC

AD

TITANIUM

AE

AK

AR

KA

KM

KO

KP

XR



WECKER
KP 495/13
13,0 cm/5"
2 mm

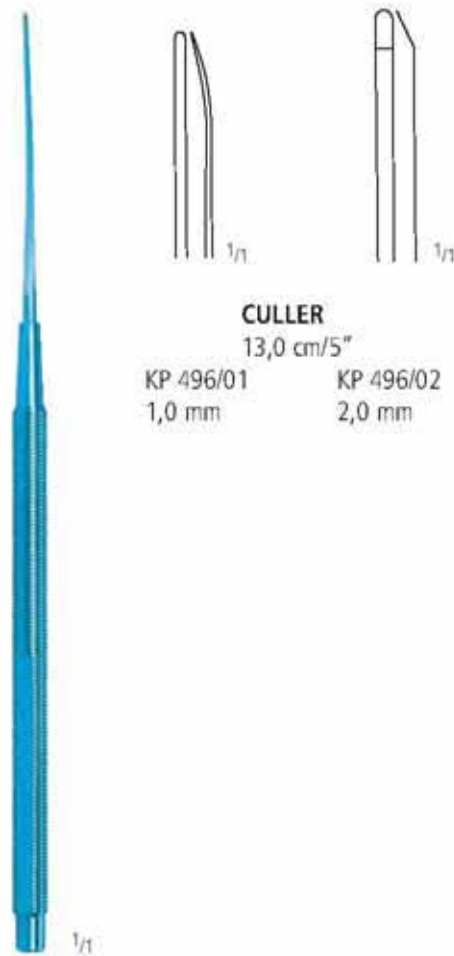

CULLER
13,0 cm/5"
KP 496/01 1,0 mm
KP 496/02 2,0 mm

Markierinstrumente optisches Zentrum, Radial- und Axialmarkierinstrumente
 Optical Zone Markers, Radial and Axis Markers
 Marcadores para centro óptico, Marcadores radiales y axiales
 Marqueurs pour centre optique, Marqueurs radiaux et axiaux
 Marcatori ottici, Marcatori radiali e assiali

TITANIUM



Ø 3,00 mm	KP 500/30
Ø 3,25 mm	KP 500/32
Ø 3,50 mm	KP 500/35
Ø 3,75 mm	KP 500/37
Ø 4,00 mm	KP 500/40
Ø 4,25 mm	KP 500/42
Ø 4,50 mm	KP 500/45
Ø 4,75 mm	KP 500/47
Ø 5,00 mm	KP 500/50
Ø 5,50 mm	KP 500/55
Ø 6,00 mm	KP 500/60
Ø 7,00 mm	KP 500/70
Ø 8,00 mm	KP 500/80
Ø 9,00 mm	KP 500/90

HOFFER
10,0 cm/4"



8 Klingen
8 blades
8 hojas
8 lames
8 lame

ANIS
KP 505/12
12,0 cm/4¾"
Ø 4 mm/12,5 mm

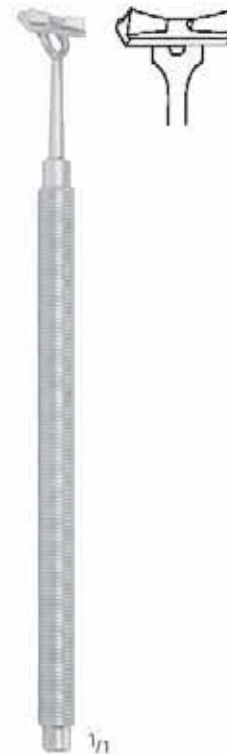

BORES
KP 508/10
10,0 cm/4"



GRANDON
KP 510/11
11,0 cm/4½"
3 mm

Hornhautmarkierinstrumente
 Corneal Markers
 Marcadores corneales
 Marqueurs cornéens
 Marcatori corneali

AA

AB

AC

AD

AE

AK

AR

KA

KM

KO

KP

XR



LINDSTROM
 KP 515/12
 12,0 cm/4³/₄"
 7 mm



LU
 KP 516/11
 10,5 cm/4¹/₄"
 Ø 8,5 mm



KP 518/10
 10,0 cm/4"



KP 519/10
 10,0 cm/4"
 Ø 5 + 11 mm

4+1 Klengen
 4+1 blades
 4+1 hojas
 4+1 lames
 4+1 lame

Hornhaut-, Limbus Inzisions-, Nahtplatzierungsmarkierinstrumente
 Corneal Markers, Limbal Incision Rulers, Suture Placement Markers
 Marcadores corneales, para incisión limbal y para suturas
 Marqueurs pour kéroplastie, pour incision limbique et à sutures
 Marcatori corneali, per incisione in limbo e per sutura



THORNTON
 KP 523/12
 12,0 cm/4³/₄"
 6-8 mm / 0,5-5,0 mm



THORNTON
 KP 530/11
 11,0 cm/4¹/₂"
 1-10 mm



ANIS
 KP 535/12
 12,0 cm/4³/₄"



GONNIN
 KP 540/13
 13,0 cm/5"
 11-23 mm / 1 mm

Tonometer, Keratometer
 Tonometers, Keratometer
 Tonómetros, Queratómetro
 Tonomètres, Kératomètre
 Tonometri, Cheratometro



SCHIOETZ
 13,0 cm/5"

gerade Skala
 straight scale
 graduado recto
 échelle droite
 scala retta

schräge Skala
 inclined scale
 graduado inclinado
 échelle oblique
 scala inclinata

Spezifikation Nr. 3
 Specification No. 3
 Especificación No. 3
 Spécification No. 3
 Specifica No. 3

KP 543/00

Spezifikation Nr. 5, geeicht
 Specification No. 5, calibrated
 Especificación No. 5, calibrada
 Spécification No. 5, calibrée
 Specifica No. 5, calibrata

KP 542/01

KP 543/01



MALONEY
 KP 545/02
 2,0 cm/3/4"

AA
 AB
 AC
 AD
 AE
 AK
 AR
 KA
 KM
 KO
 KP
 XR

Messinstrumente, Tiefenlehre, Fixierringe
 Measuring Instruments, Depth Gauge, Fixation Rings
 Instrumentos de medición, Medidor de profundidad, Anillos de fijación
 Instruments de mesure, Jauge de profondeur, Anneaux de fixation
 Strumenti per la misurazione, Misuratori di profondità, Anelli di fissazione



MENDEZ
 KP 547/11
 11,0 cm/4 1/2"
 C 10°, 0 - 180°



DEITZ
 9,5 cm/3 3/4"
 KP 548/50 KP 548/55
 0,50 mm 0,55 mm



THORNTON
 KP 550/12
 12,0 cm/4 3/4"
 Ø 13 mm



BONN
 KP 555/11
 10,5 cm/4 1/4"

Hornhautbohrer und -trephinen
 Corneal Burrs and Trephines
 Fresas y trépanos corneales
 Trépanos kératoplastie
 Trepani corneali

AA

AB

AC

AD

AE

AK

AR

KA

KM

KO

KP

XR



1/1

CASTROVIEJO

5,0 cm/2"

mm Ø

5,0	KP 600/50
5,5	KP 600/55
6,0	KP 600/60
6,5	KP 600/65
7,0	KP 600/70
7,5	KP 600/75
8,0	KP 600/80
9,0	KP 600/90



1/1

FRANCESCHETTI

7,5 cm/3"

mm Ø

7,0	KP 603/70
7,1	KP 603/71
8,0	KP 603/80
8,1	KP 603/81



1/1

MARTIN

4,0 cm/1 1/2"

mm Ø

5,0	KP 605/50
5,5	KP 605/55
6,0	KP 605/60
6,5	KP 605/65
6,7	KP 605/67
7,0	KP 605/70
7,2	KP 605/72
7,5	KP 605/75

mm Ø

7,7	KP 605/77
8,0	KP 605/80
8,2	KP 605/82
8,5	KP 605/85
8,7	KP 605/87
9,0	KP 605/90
9,5	KP 605/95

Hornhautbohrer und -trephinen
 Corneal Burrs and Trephines
 Fresas y trépanos corneales
 Trépanis kératoplastie
 Trepani corneali



ELLIOT
 KP 611/00
 3,0 cm/1¹/₄"



ELLIOT
 KP 612/10
 Ø 1,0 mm



ELLIOT
 KP 612/15 KP 612/20
 Ø 1,5 mm Ø 2,0 mm

ELLIOT SET

- KP 610/00 = KP 611/00
- KP 612/10
- KP 612/15
- KP 612/20

mit Etui
 with case
 con estuche
 avec boîte
 con scatola



STORZ
 KP 620/08
 8,0 cm/3¹/₄"

mit 6 Fräsen
 with 6 burrs
 con 6 fresas
 avec 6 fraises
 con 6 fresas

Rostringfräse, Fixierringe,
Rust Ring Remover, Scleral Fixation Rings
Anillo removedor de óxido, Anillos de fijación
Fraise pour enlever la rouille, Anneaux de fixation
Fresa corneale, Anelli di fissazione



**RUST RING
REMOVER SET**
KP 630/00
12,5 cm/5"



KP 631/00
6 Fräsen
6 burs
6 fresas
6 fraises
6 fresas

KP 632/00
Batterie, 2 Stück
Battery, 2 pieces
batería, 2 piezas
piles, 2 pièces
pile, 2 pezzi

KP 630/00 = KP 631/00 + KP 632/00



FLIERINGA

mm Ø	
14	KP 640/14
16	KP 640/16
18	KP 640/18
20	KP 640/20
22	KP 640/22
24	KP 640/24

AA
AB
AC
AD
AE
AK
AR
KA
KM
KO
KP
XR

Vorderkammerspülkanülen, Silikonball, Verbindung, Spülkanülen
 Anterior Chamber Irrigation Cannula, Silicon Ball, Connection, Irrigation Cannulas
 Cánulas de irrigación para cámara anterior, Pelota de silicona, Conector, Cánulas para irrigación
 Canules à lavage pour chambre antérieure, Balle de silicone, Raccord, Canules irrigatrices
 Cannule d'irrigazione per camera anteriore, Palla di silicone, Raccordo, Cannule d'irrigazione



BISHOP-HARMON
 KP 700/00

Set komplett
 Set complete
 Juego completo
 Jeu complet
 Set completo

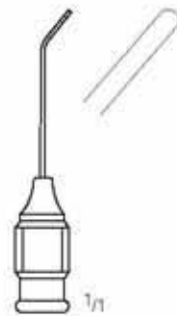

BISHOP-HARMON
 KP 701/19
 4,0 cm/1 1/2"
 19G



KP 702/00
 7,5 cm/2 3/4"

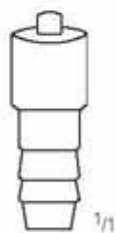

LUER-LOCK
 KP 703/00
 3,0 cm/1 1/4"

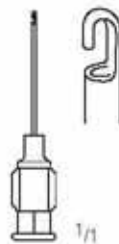

McINTYRE
 KP 704/23
 3,0 cm/1 1/4"
 23G

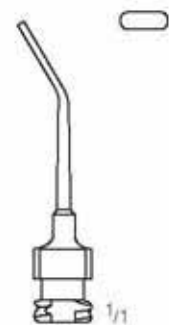

MODELL BONN
 4,0 cm/1 1/2"
 KP 705/19 KP 705/20
 19G 20G

Vorderkammer-, Saug- und Spülkanülen, Luftkanülen
 Anterior Chamber, Irrigation and Aspiration Cannulas, Air Injection Cannulas
 Cánulas para cámara anterior, irrigación y aspiración, Cánulas para inyectar aire
 Canules à chambre antérieure, irrigatrices et pour aspiration, Canules à injection d'air
 Cannule per camera anteriore, d'irrigazione e d'aspirazione, Cannule per iniettare aria

AA
AB
AC
AD
AE
AK
AR
KA
KM
KO
KP
XR

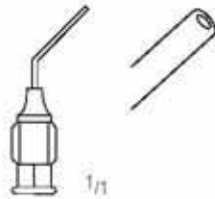

McINTYRE
 2,5 cm/1"
 KP 712/27 KP 712/30
 27G 30G

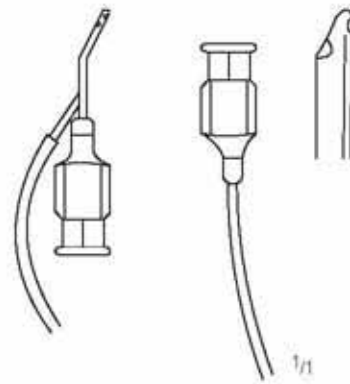

SIMCOE
 KP 720/23
 3,0 cm/1¹/₄"
 25/23G

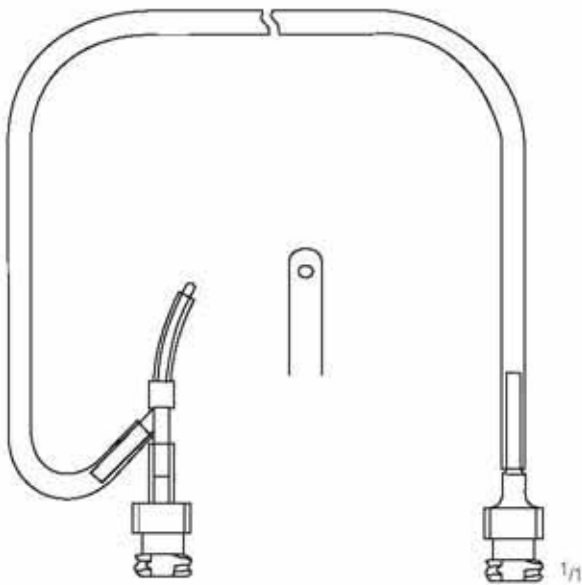

FRIEDBURG
 KP 721/00
 4,0 cm/1¹/₂" 3,0 cm/1¹/₄"

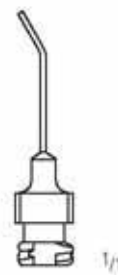

SAUTTER
 KP 730/27 KP 730/30
 27G 30G
 3,5 cm/1¹/₂"



SAUTTER
 KP 731/27
 3,5 cm/1¹/₂"
 27G

Tränenwegkanülen, Kortex Extraktor
 Lacrimal Cannulas, Cortex Extractor
 Cánulas lacrimales, Extractor para corteza
 Canules à voies lacrymales, Extracteur de cortex
 Cannules per vie lacrimali, Estrattore per capsula



ANEL
 KP 740/23
 4,0 cm/1 1/2"
 23G



KP 741/23
 3,5 cm/1 1/2"
 23G

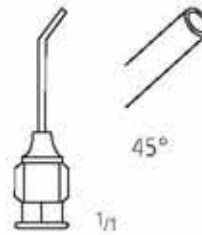

GILLS-WELSH
 KP 745/25
 3,0 cm/1 1/4"
 25G

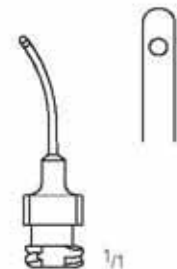

SIMCOE
 KP 746/23
 3,0 cm/1 1/4"
 23G

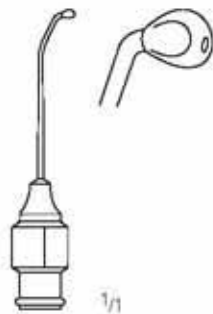

WELSH
 KP 747/00
 4,0 cm/1 1/2"
 25G

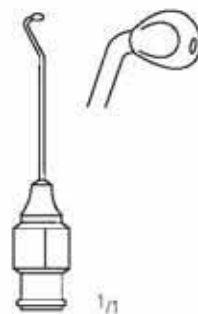

WELSH
 KP 747/01
 4,0 cm/1 1/2"
 25G

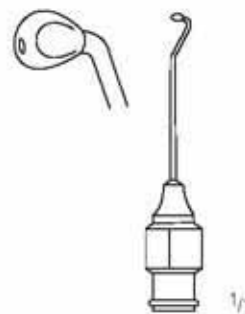

WELSH
 KP 747/02
 4,0 cm/1 1/2"
 25G

Linsenschlinge und Linsenkernschlinge mit Spülung, Injektionskanüle
 Lens Loop and Lens Nucleus Loop with Irrigation, Injection Cannula
 Asas para cristalino y Cánula para núcleo con irrigación, Cánula para inyección
 Anses à cristallin et Canula du noyau avec irrigation, Canule à injection
 Anse per cristallino con irrigazione, Irrigatore per lenti intraoculari, Cannula per lavaggio

AA
AB
AC
AD
AE
AK
AR
KA
KM
KO
KP
XR

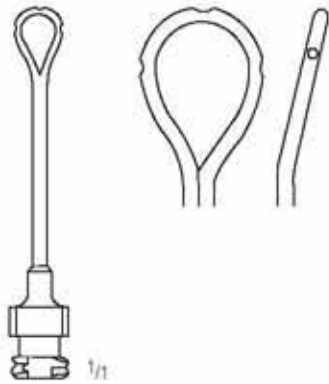

KNOLLE-PEARCE
 KP 755/23
 5,0 cm/2"
 23G

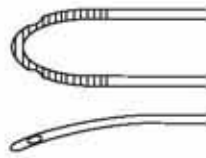

SIMCOE
 3,0 cm/1 1/4"
 KP 756/01
 25G

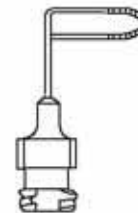
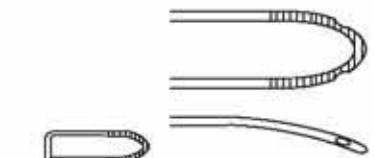

KP 756/02
 25G

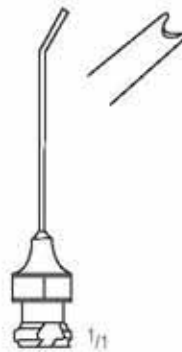

KP 760/21
 4,5 cm/2"
 21G

Kapselpolierer, Kapselpeile, Kapselsauger
 Capsule Polisher, Capsule Scraper, Erisiphake
 Pulidor para cápsula, Erisiphake
 Canule gratteuse, Erisiphaque capsulaire
 Levigatore corneale, Aspiratore capsulare

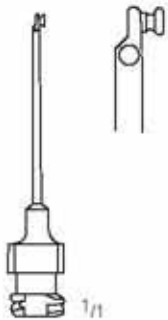

KP 763/01
23G

GRAETHER
4,0 cm/1 1/2"

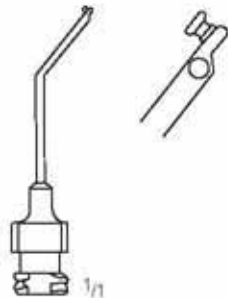

KP 763/02
23G

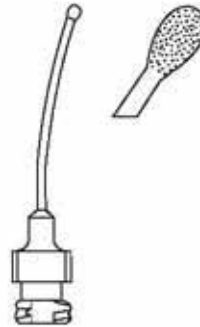

JENSEN
KP 767/27
4,5 cm/2"
27G

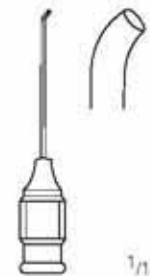

KNOLLE
3,5 cm/1 1/2"
KP 768/23
23G

KP 768/30
30G



KRATZ
3,5 cm/1 1/2"
KP 772/01
23G
L = 1 mm

KP 772/02
23G
L = 2 mm

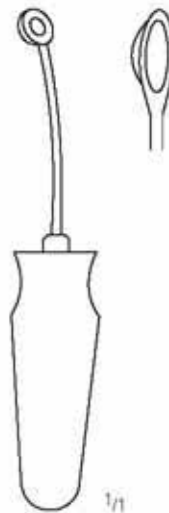

BELL
KP 775/00
6,5 cm/2 1/2"

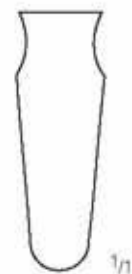

BELL
KP 775/01

Zyklodialysen-, Alpha-Chymotrypsin- und Zystotomkanüle
 Cyclodialysis-, Alpha-Chymotrypsin- and Cystotome Cannula
 Cánula para ciclodialísis, Alpha-Chymotrypsin y cistótomo
 Canule pour cyclodialyse, à injection Alpha-Chimo-Trypsine et cystotome
 Cannule per ciclodialisi, per alfa-chimotripsina e per cistotomi

AA

AB

AC

AD

AE

AK

AR

KA

KM

KO

KP

XR

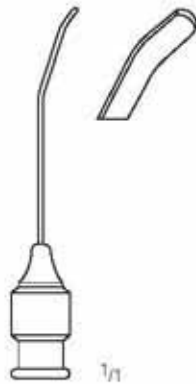

KELMAN
4,0 cm/1 1/2"

KP 780/01
19G

KP 780/02
19G

rechts
right
derecho
droit
destro

links
left
izquierda
gauche
sinistro

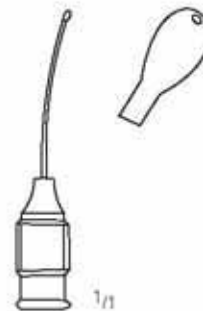

TROUTMAN

KP 783/25
4,5 cm/2"

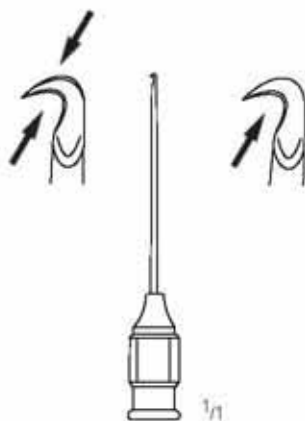

KELMAN
4,5 cm/2"

KP 786/00
22G

KP 786/01
22G

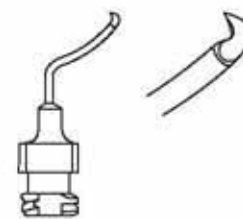

KRATZ

KP 788/22
3,0 cm/1 1/4"
22G

Augennadeln
 Eye Needles
 Agujas oculares
 Aiguilles ophtalmiques
 Aghi oftalmichi

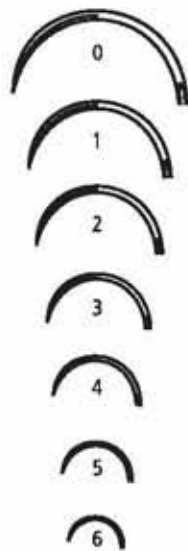

OG
 gebogen 1/2 Kreis
 curved 1/2 circle
 curvas 1/2 círculo
 courbes 1/2 cercle
 curvi 1/2 círculo

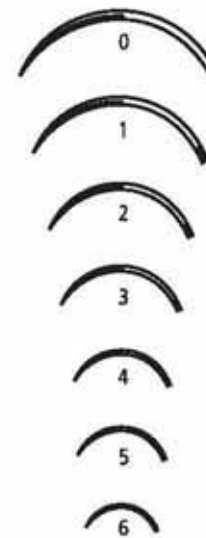

OB
 gebogen 3/8 Kreis
 curved 3/8 circle
 curvas 3/8 círculo
 courbes 3/8 cercle
 curvi 3/8 círculo



gewöhnliches Ohr
 regular eye
 ojo ordinario
 chas régulier
 cruna ordinaria

Federohr
 spring eye
 ojo de resorte
 chas à ressort
 cruna a molla

- KP 950/00
- KP 950/01
- KP 950/02
- KP 950/03
- KP 950/04
- KP 950/05
- KP 950/06

- KP 951/00
- KP 951/01
- KP 951/02
- KP 951/03
- KP 951/04
- KP 951/05
- KP 951/06

- FIG. 0**
- FIG. 1**
- FIG. 2**
- FIG. 3**
- FIG. 4**
- FIG. 5**
- FIG. 6**



gewöhnliches Ohr
 regular eye
 ojo ordinario
 chas régulier
 cruna ordinaria

Federohr
 spring eye
 ojo de resorte
 chas à ressort
 cruna a molla

- KP 952/00
- KP 952/01
- KP 952/02
- KP 952/03
- KP 952/04
- KP 952/05
- KP 952/06

- KP 953/00
- KP 953/01
- KP 953/02
- KP 953/03
- KP 953/04
- KP 953/05
- KP 953/06

Verkaufseinheit 1 Dutzend
 unit for sale 1 dozen
 unidad de venta 1 docena
 unité d' 1 douzaine
 unità di vendita 1 dozzina

Augenklappen, Pinsel
 Eye Patches, Brushes
 Protectores de ojos, Pincel
 Bandeaux pour les yeux, Pinceau
 Benda di protezione per gli occhi, Pennello



KP 955/01



KP 955/02



KP 956/00



BARRAQUER
 KP 959/00

AA
 AB
 AC
 AD
 AE
 AK
 AR
 KA
 KM
 KO
 KP
 XR

HF-ZUBEHÖR
HF-ACCESSORIES
AF-ACCESORIOS
HF-ACCESSOIRES
AF-ACCESSORI

XR

nopa[®] instruments



Anschlußkabel, Bi-Koagulations-Pinzetten
 Connection Cords, Bi-Coagulation-Forceps
 Cables de conexión, Pinzas para Coagulación
 Câbles de raccordement, Pincas pour Bi-Coagulation
 Cavi da connessione, Pinze per la Bi-Coagulazione

AA
AB
AC
AD
AE
AK
AR
KA
KM
KO
KP
XR

bipolar



MARTIN / BERCHTHOLD

300 cm XR 830/03
 500 cm XR 830/05

bipolar



ERBE/SELECT

XR 832/03
 XR 832/05

D=0,5 mm

E=Nadel



11,0 cm/4 ¹ / ₃ "	XR 898/11 D	XR 899/11 D
11,0 cm/4 ¹ / ₃ "	XR 898/11 E	XR 899/11 E

