

ATMOS® Chair 41 Gyne

Gynaecological Patient Chair

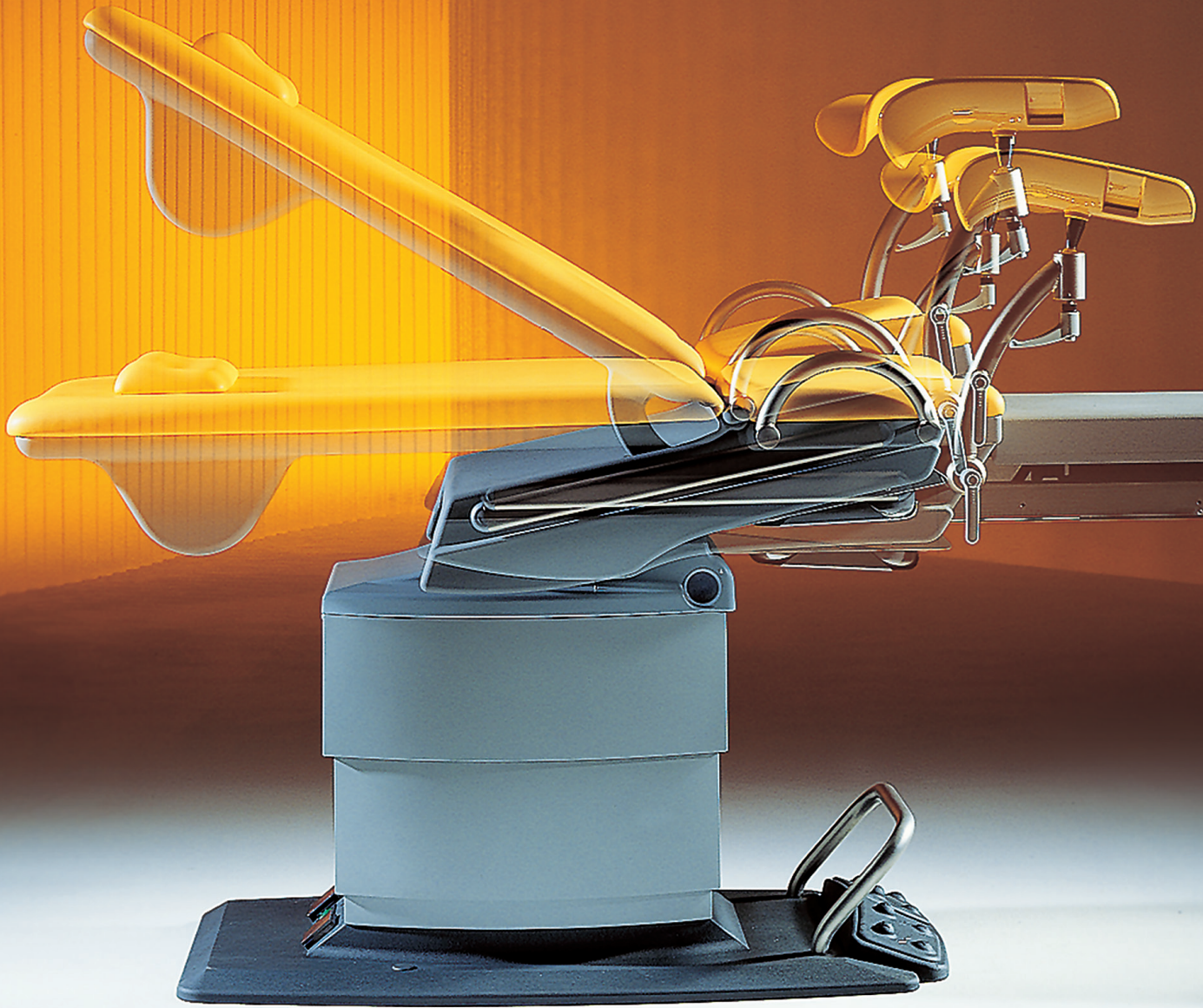

Gynaecological patient chair: ATMOS® Chair 41 Gyne



The innovative examination chair that offers the gentle alternative

With more sensitivity, flexibility and individuality.

ATMOS breathes new life into your surgery:

It is fully flexible in height with any inclination in any position. That is our interpretation of flexibility and individuality for each patient. We develop concepts that meet your specifications – the chair can quickly and gently be moved into an anatomically optimum examination position at the touch of a button.

Patient well-being, security and sensitivity

are not simply words. They represent the targets ATMOS has set for themselves in developing the innovative examination chair for gynaecological surgery.



Easy to sit down also for older and disabled patients:

Electromotive height adjustment from 570 to 900 mm. A minimal access height of 540 mm is obtained by tilting the seat.

Functionality:

The chair is adaptable to any examination position, whatever the situation. The optionally integrated leg rest is easily brought into the examination area when required and changes the examination chair into a couch.

Optimum examination position:

The smooth electromotive adjustment allows easy positioning and by the integrated memory function it can quickly be recalled.

Quick adjustment:

During the examination, every setting can be preprogrammed and regulated or precision-adjusted. At the push of a button simultaneously operating motors bring the patient quickly into position.

Flexibility:

All leg holders can be moved in 3 directions. The innovative leg supports from ATMOS no longer fix the legs. They are rested with relaxation and security on the supports! For therapy purposes the conventional leg holders "Goepel" are also available.



The most striking innovation ...

... is to answer the demand for a completely relaxed examination environment.

The combination of comfortable, ergonomic leg holders and the pre-programmed precision control for each seating and horizontal position frees you from restrictions during gynaecological examinations.

This means greater convenience for you and increased comfort for your patients. Make the ATMOS® Chair 41 Gyne your first choice and win your patient's approval.

The ATMOS® Chair 41 Gyne is adaptable: to your needs and your budget

We go to extreme to provide you with freedom of choice.

ATMOS® Chair 41 Gyne gives you and your patient freedom of choice. Every human being has a different build. And every surgery and every specialist department requires a unique solution.

ATMOS® Chair 41 Gyne can be adapted to these requirements. You have the choice of ergonomic leg plates or adjustable holders. By request, we can also provide you with both versions. They are easily interchangeable. All versions are ergonomically and anatomically perfect. Add to this a wide range of accessories. Specially designed for procedures in gynaecology.

Variable

Precision-adjustable leg plates or leg holders in various versions and colours.

Ready at any time

The extra-low drainage pan is easily pulled out when required. When the patient is repositioned, the drainage pan swings automatically into place, with no spillage.

Positioned in an instant

User-friendly and absolutely hygienic, the magnetic head restraint is always in the ideal position.

An all-in-one solution

safety for your patient, freedom of movement for you, e.g. during ultrasound examinations

Colposcope holder

Colposcope holder mountable at both sides. Perfect for the ATMOS i View Colpo.

Press and ready

The ideal position is only a touch of a button away: all positions are preprogrammable and retrievable. Positions can be adjusted to meet individual needs at any time.



Exchange could not be easier

The paper rolls can be changed easily and quickly for any examination position.



Ergonomic and strong

Doctor's foot rest. The generous stainless steel tray gives reliable support for the clinician.

The all-round carefree package

It is possible to accurately adapt the ATMOS® i View to individual requirements. For gynaecologists many features make it a flexible all-round product which possesses superior, comprehensive and high-class technology, the like of which is pioneering in the field of diagnosis.

For the easy positioning of the colposcope head, the colposcope arm can be equipped with needle bearings.

Apart from the characteristics which facilitate work and the additional modules, we have also paid attention to data processing: many features of the ATMOS® i View serve to ensure safety and ensure straightforward data handling. Among others, these include the integrated camera as well as the PC archiving software with a patient database.

Service is traditionally one of the most important aspects at ATMOS. Our service team worldwide strives to keep over 100 workstations alone in German clinics in good working condition thereby preventing downtime.





Technical Data

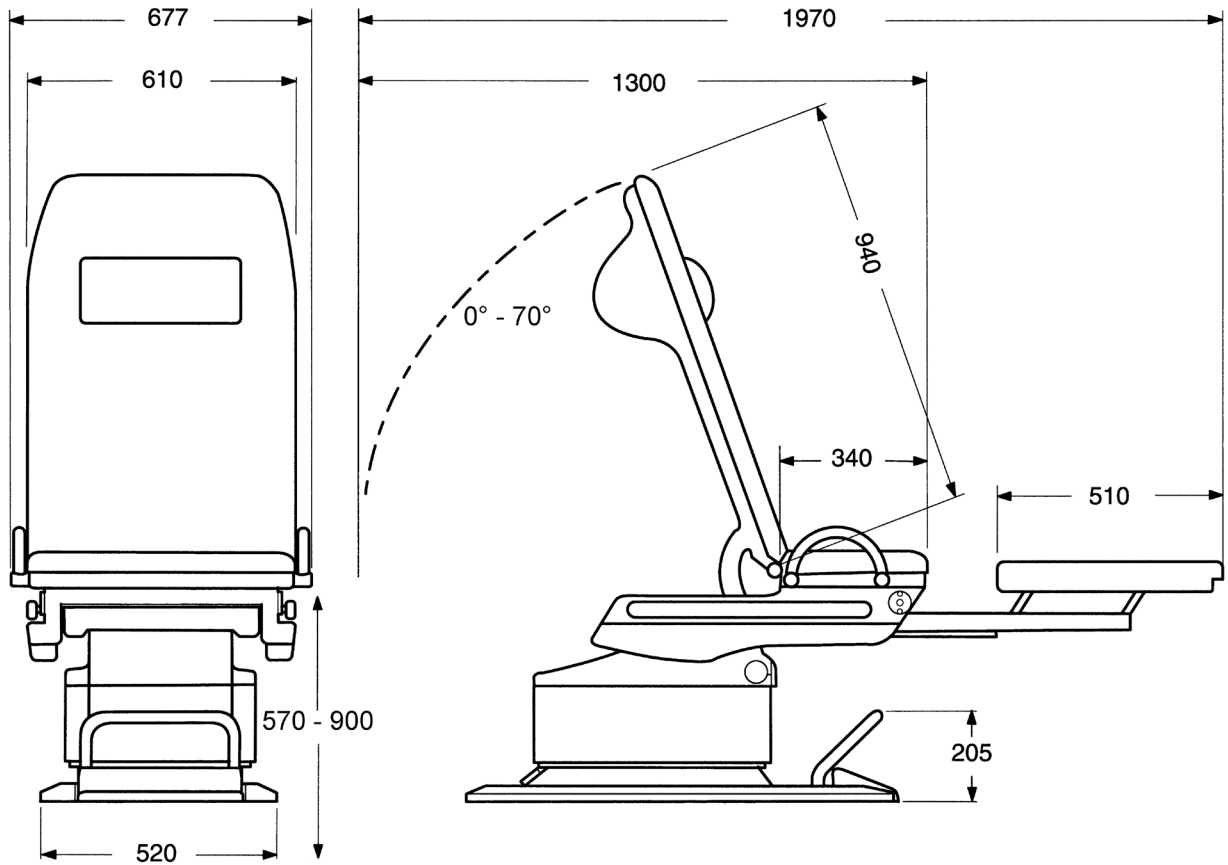









Technical data	ATMOS® Chair 41 Gyne
Power supply	230 V ± 10%
Dimensions (H x B x T)	see above
Rated frequency	50/60 Hz
Fuses	2 x T 3, 15 A, 250 V
Protection class (EN 60601-1)	I
Degree of protection	Typ B
Trendelenburg position	-10° / +25°

The technical data is valid at the time of printing, subject to change!

Accessories & Consumables

ATMOS® Chair 41 Gyne		REF
¹ ATMOS® Chair 41 Gyne Special voltage: 110 V, 115 V, 127 V Please state color and required voltage.		503.0549.0
Leg holders "Goepel"		REF
² 1 pair, without cushion		503.0551.0

Color	ATMOS® Chair 41 Gyne	Headrest magnetic pillow	Leg support all-cushion 1 pair	Leg support stain-less steel, with cushion, foot support plate 1 pair	Cushion for leg holders „Goepel"	Doctors chair
	¹	²	³	⁴	⁵	¹⁰
Pastel blue 	503.0550.0	503.0556.0	503.0558.0	503.0554.0	503.0565.0	503.0570.0
Saffron yellow 	503.0550.1	503.0556.1	503.0558.1	503.0554.1	503.0565.1	503.0570.1
Salmon 	503.0550.2	503.0556.2	503.0558.2	503.0554.2	503.0565.2	503.0570.2
Leaf green 	503.0550.3	503.0556.3	503.0558.3	503.0554.3	503.0565.3	503.0570.3
Light grey 	503.0550.4	503.0556.4	503.0558.4	503.0554.4	503.0565.4	503.0570.4
Silk grey 	503.0550.5	503.0556.5	503.0558.5	503.0554.5	503.0565.5	503.0570.5
White 	503.0550.6	503.0556.6	503.0558.6	503.0554.6	503.0565.6	503.0570.6
Sapphire blue 	503.0550.7	503.0556.7	503.0558.7	503.0554.7	503.0565.7	503.0570.7

Accessories & Consumables

furthers Accessories		REF
[6]	Handles, 1 pair, stainless steel	503.0573.0
	Colposcope holder to be mounted to the left or to the right for ATMOS i View, Kaps and Zeiss	503.0553.0
[7]	Foot rest for the doctor	503.0559.0
[8]	Drainage pan stainless steel	503.0555.0
[9]	Leg rest extendable, width 440 mm (complete length 1970 mm), colour grey	503.0552.0
	Stainless steel secretion basin including add-on kit Extendable, pivot-mounted. Secretion basin is removable. Technical Data: Dimensions (W x H x D): 65 x 325 x 265 mm <i>Included in delivery: add-on kit, stainless steel secretion basin</i>	503.0581.0
Consumables		REF
	Paper roll for gynaecological examination chair, W = 39 cm, L = 50 m	503.0557.0
	Synthetic protection cover for cushioned foot plates	503.0567.0
Gynaecological LED examination lamp		REF
	Powerful LED examination lamp for gynaecology to be mounted to the examination chair/couch.	600.0191.0



1 ATMOS® Chair 41 Gyne



2 Heandrest magnetic pillow



3 Leg support all-cushion



4 Leg support stainless steel



5 Leg holder "Goepel"



6 Handles



7 Foot rest for the doctor



8 Drainage pan stainless steel



9 Leg rest



10 Doctor's chair



MedizinTechnik

ATMOS MedizinTechnik GmbH & Co. KG
Ludwig-Kegel-Str. 16
79853 Lenzkirch / Germany
Tel: +49 7653 689-374
atmos@atmosmed.de

www.atmosmed.com