

---

ABDOMINAL

GYN

**SET** ZS 140/00

Siebvorschlag - Suggested instrument set



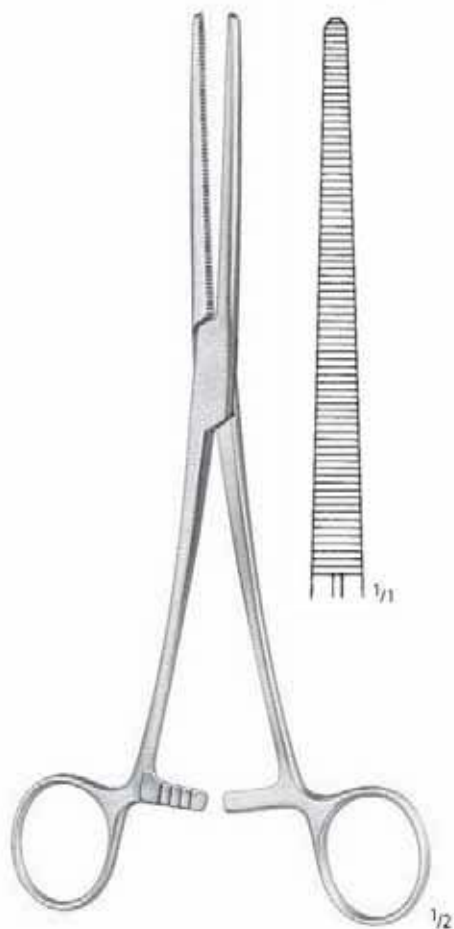

**ROCHESTER-PEAN**  
AA 200/24  
24,0 cm/9 1/2"



**OCHSNER-KOCHER 1:2**  
AA 210/24  
24,0 cm/9 1/2"

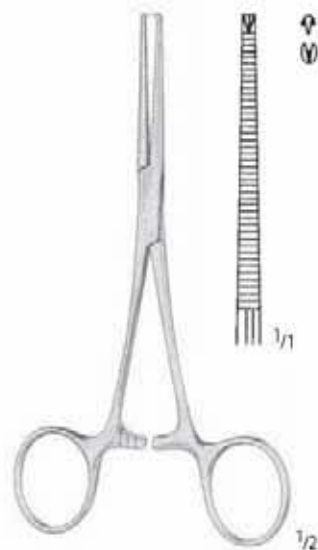

**KOCHER 1:2 - DELICATE**  
AA 216/14  
14,0 cm/5 1/2"

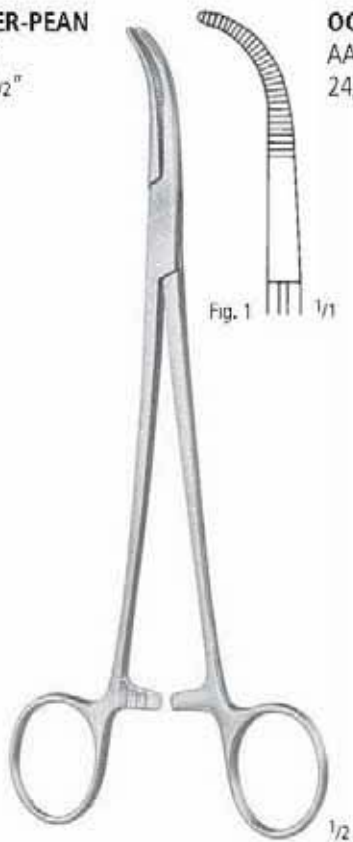

**OVERHOLT-GEISSENDOERFER**  
AA 223/01  
27,0 cm/10 3/4"



**RUMEL**  
AA 335/03  
23,0 cm/9"

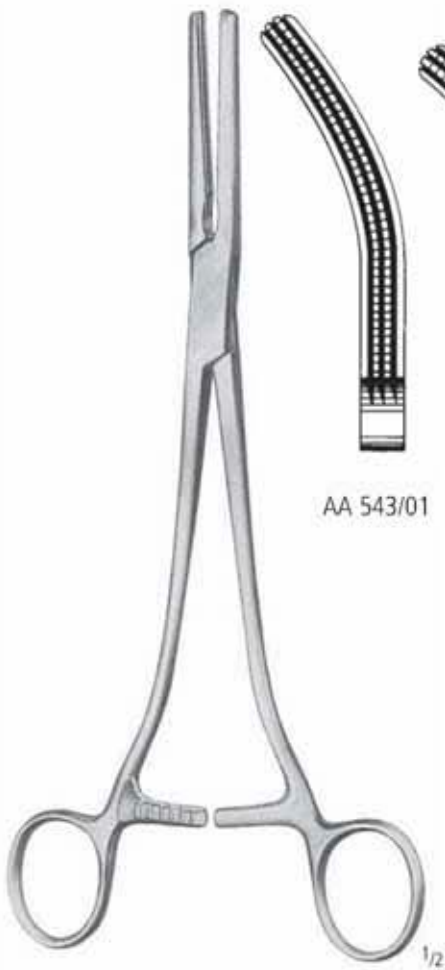

**PARAMETRIUM**  
24,0 cm/9 1/2"

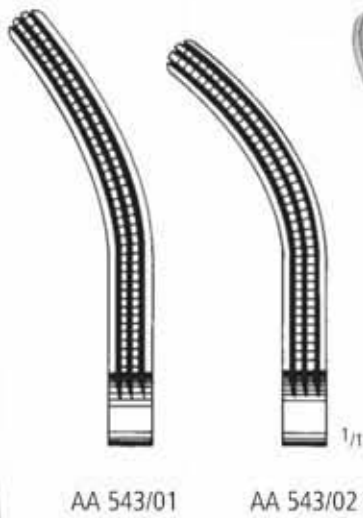

AA 543/01

AA 543/02

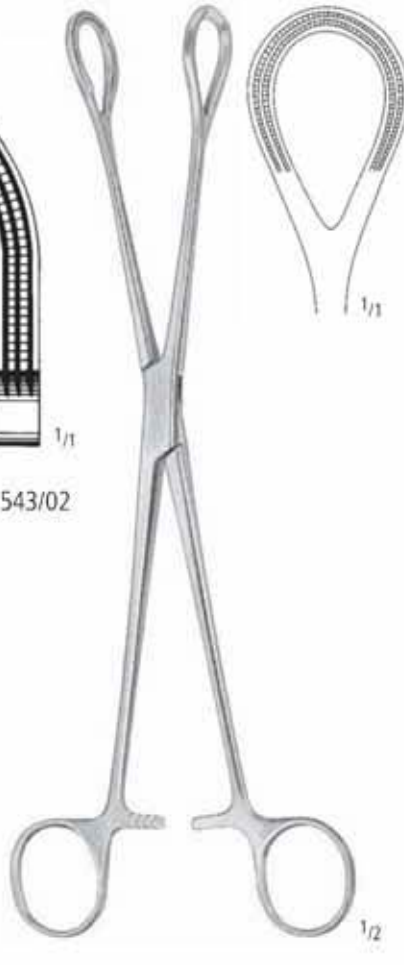

AA 558/25  
25,0 cm/10"

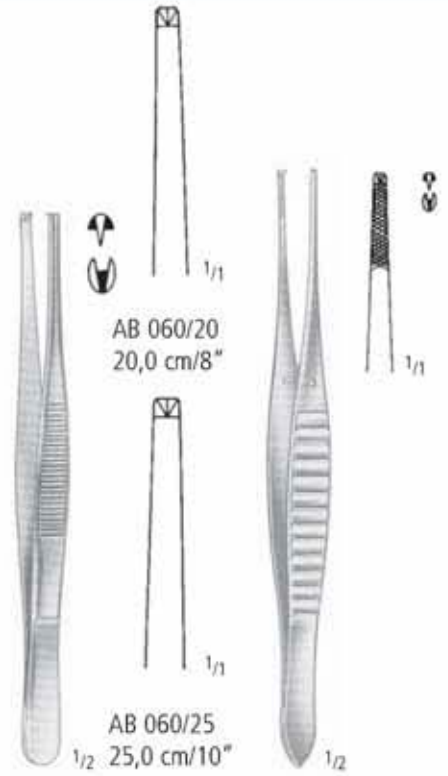

**1:2  
STANDARD**

**GILLIES 1:2**  
AB 430/15  
15,0 cm/6"

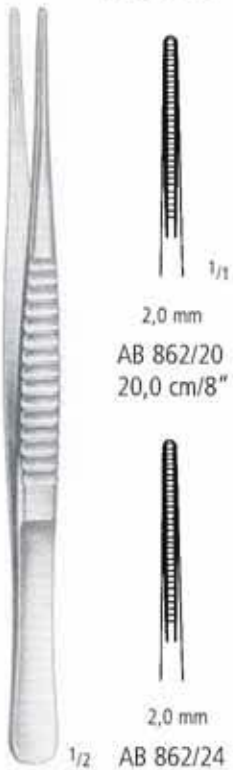

**DE BAKEY**

2,0 mm  
AB 862/20  
20,0 cm/8"

2,0 mm  
AB 862/24  
24,0 cm/9 1/2"

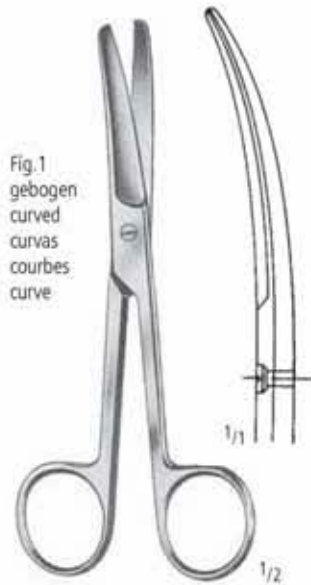

**STANDARD**  
AC 011/15  
15,5 cm/6"

Fig.1 gebogen  
curved  
curvas  
courbes  
curve



AC 091/20  
20,0 cm/8"

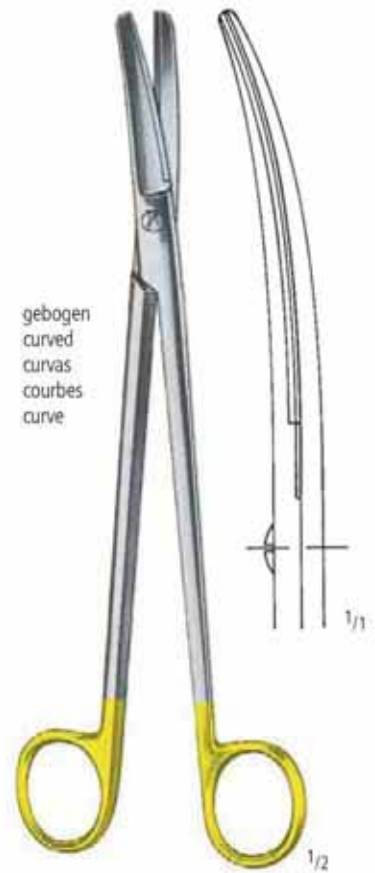

**SIMS**  
AC 919/23  
23,0 cm/9"

gebogen  
curved  
curvas  
courbes  
curve

ZS 140/00 GYNECOLOGY ABDOMINAL SET

gebogen  
curved  
curvas  
courbes  
curve

gebogen  
curved  
curvas  
courbes  
curve



**METZENBAUM**  
AC 941/20  
20,0 cm/8"

**METZENBAUM-DELICATE**  
AC 971/25  
25,0 cm/10"

AD 010/04  
No. 4

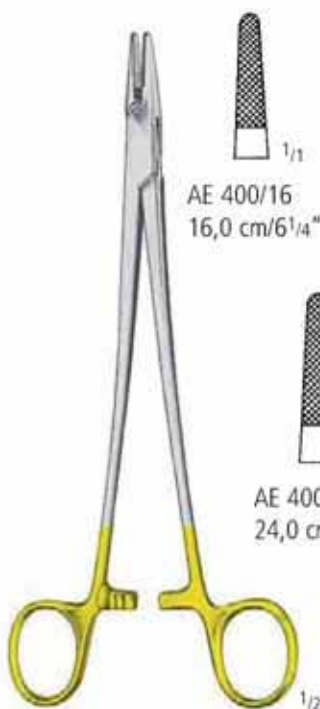

**MAYO-HEGAR**

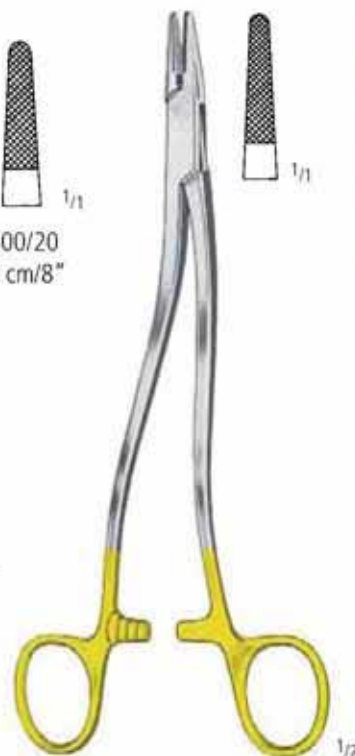

**BOZEMANN**  
AE 476/24  
24,0 cm/9 1/2"



**GROSS-MAIER**  
AF 100/27  
27,0 cm/10 3/4"



**GROSS-MAIER**  
AF 101/27  
27,0 cm/10 3/4"

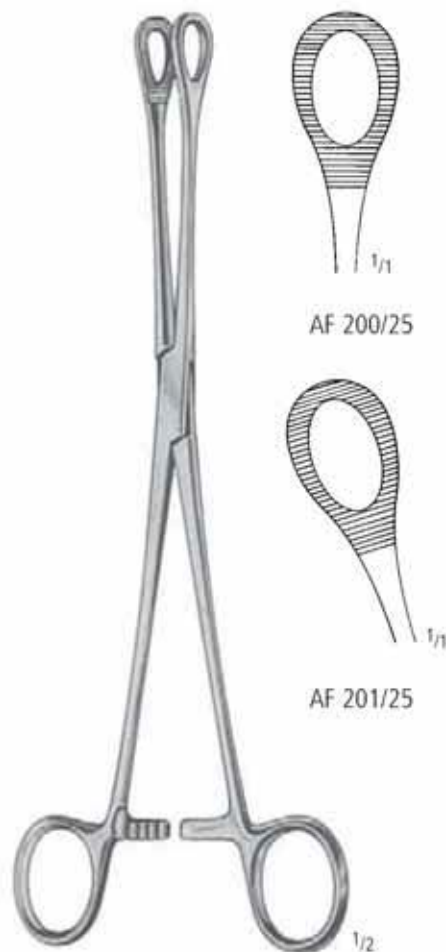

**FOERSTER-BALLENGER**  
25,0 cm/10"

GYN

ZS 140/00

ZS 140/05

ZS 140/10

ZS 140/25

ZS 140/30

ZS 140/35

ZS 140/40

ZS 140/45

ZS 140/55

ZS 981/04

ZS 140/55

ZS 140/60

ZS 140/65

ZS 140/70

ZS 140/75

ZS 140/80

ZS 140/85

ZS 140/90

ZS 140/95

ZS 140/100

ZS 140/105

ZS 140/110

ZS 140/115

ZS 140/120

ZS 140/125

ZS 140/130

ZS 140/135

ZS 140/140

ZS 140/145

ZS 140/150

ZS 140/155

ZS 140/160

ZS 140/165

ZS 140/170

ZS 140/175

ZS 140/180

ZS 140/185

ZS 140/190

URO

ZS 981/01

ZS 981/02

ZS 981/03

ZS 981/04

ZS 981/05

ZS 981/06

ZS 981/07

ZS 981/08





**FRITSCH**  
24,0 cm / 9 1/2"  
45 x 75 mm AK 254/75



**ROUX**  
16,5 cm / 6 1/2"  
Fig. 1 AK 350/01  
Fig. 3 AK 350/03



biegsam  
malleable  
maleables  
malléables  
malleabili



33,0 cm / 13"  
40 mm AK 804/40 14 AO 820/14



**BREISKY**  
130 x 30 mm  
KB 093/30



**SCHRÖDER**  
KB 255/25  
25,0 cm / 10"



**SCHRÖDER**  
KB 262/24  
24,0 cm / 9 1/2"

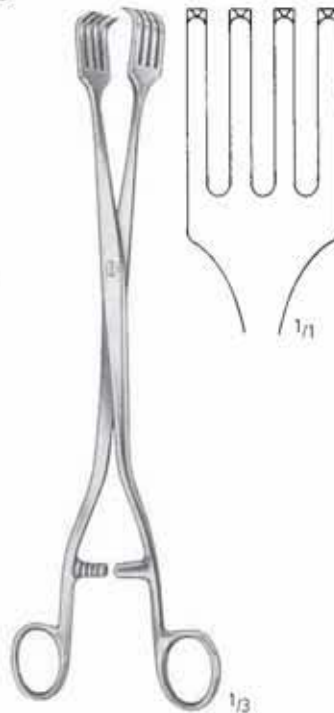

**PRATT**  
KB 265/28  
28,0 cm / 11"

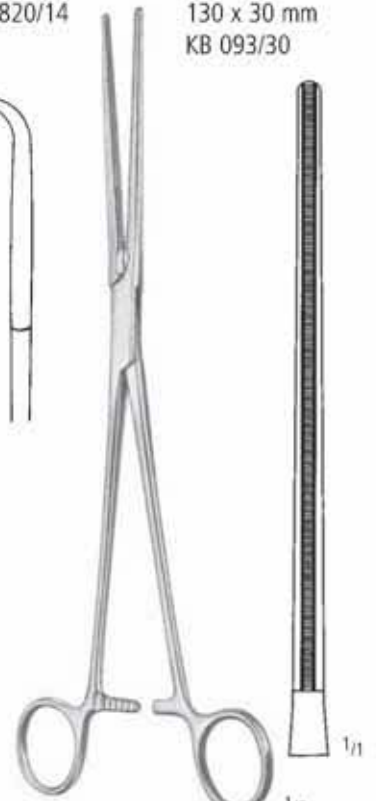

**DE BAKKEY**  
KK 486/27  
27,0 cm / 10 1/2"



Ø x h  
80 x 40 mm 0,14 l KU 300/08



L = 250 mm KU 302/25



KU 303/65  
Ø = 65 mm



MARTIN/BERCHTOLD  
XR 803/05



XR 841/01



XR 843/04



L(mm)	B(mm)	H(mm)	
540	255	50	SK 307/05

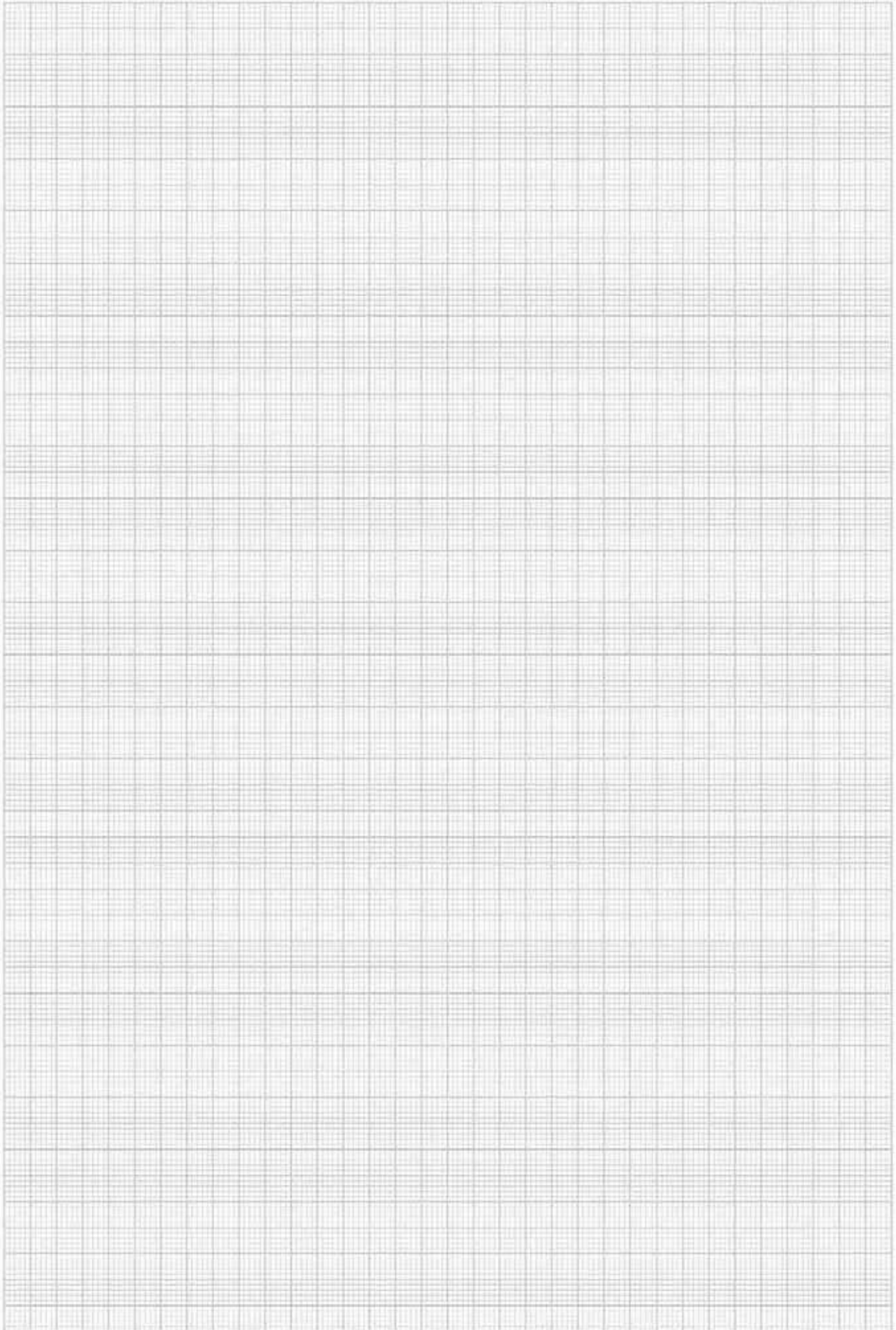

---

VAGINAL - HYSTERECTOMY

GYN

**SET**

ZS 140/05

Siebvorschlag - Suggested instrument set





ZS 140/05 VAGINAL-HYSTERECTOMY SET

GYN

ZS 140/00 ZS 140/05 ZS 140/10 ZS 140/25 ZS 140/30 ZS 140/35 ZS 140/40 ZS 140/45 ZS 140/55 ZS 981/04 ZS 981/01 ZS 145/05 ZS 981/02

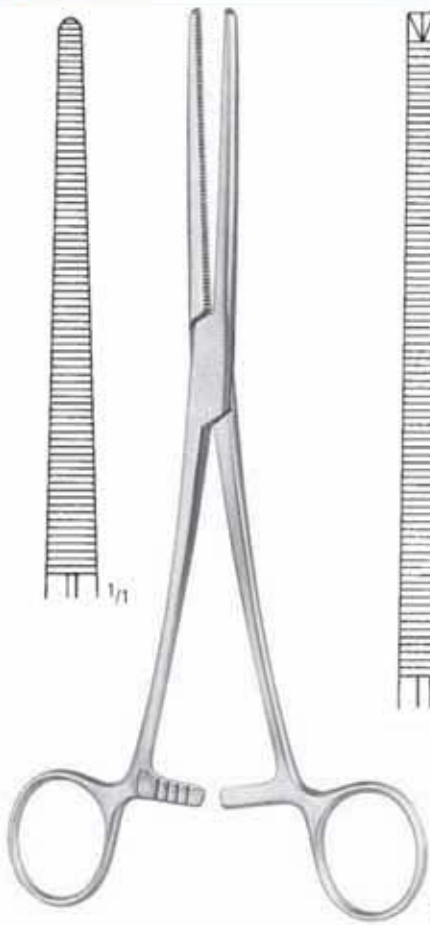

**ROCHESTER-PEAN**  
AA 200/24  
24,0 cm/9 1/2"

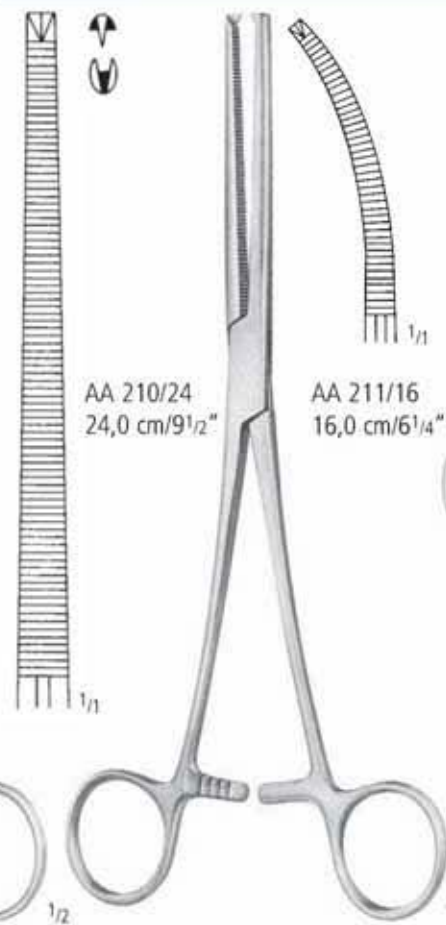

**OCHSNER-KOCHER 1:2**  
24,0 cm/9 1/2"

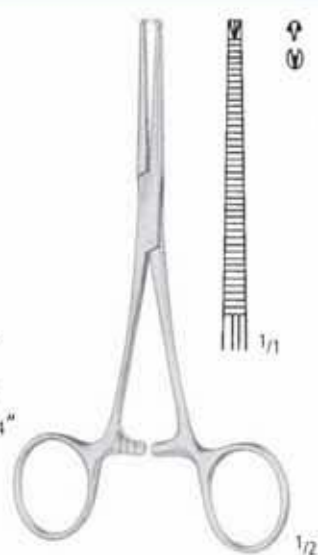

**KOCHER 1:2 - DELICATE**  
AA 216/14  
14,0 cm/5 1/2"

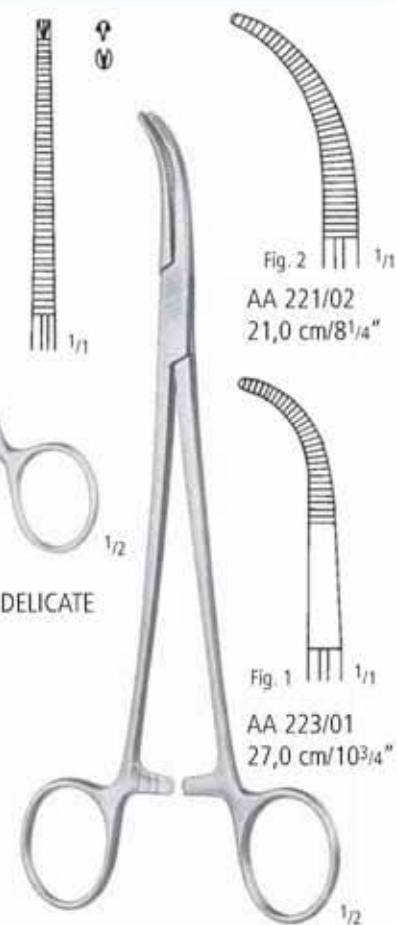

**OVERHOLT-GEISSENDOERFER**  
21,0 cm/8 1/4"



**RUMEL**  
23,0 cm/9"

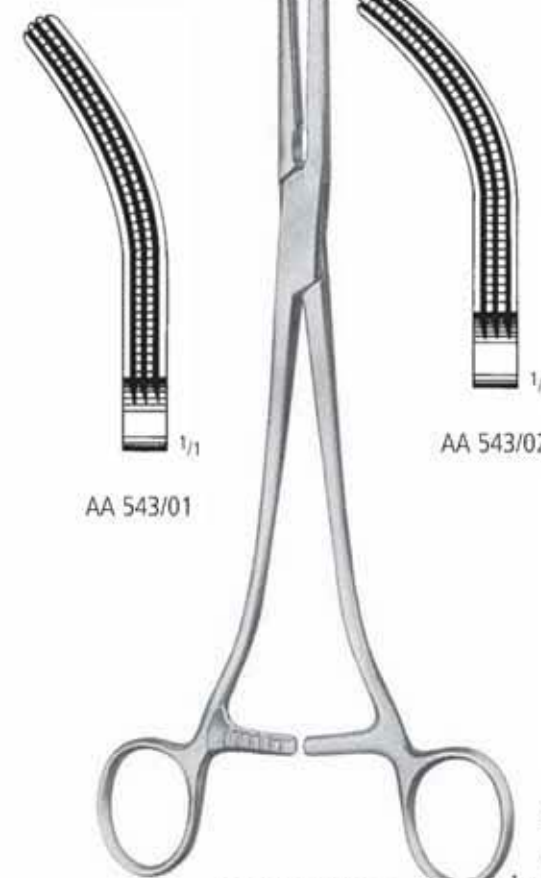

**PARAMETRIUM**  
24,0 cm/9 1/2"

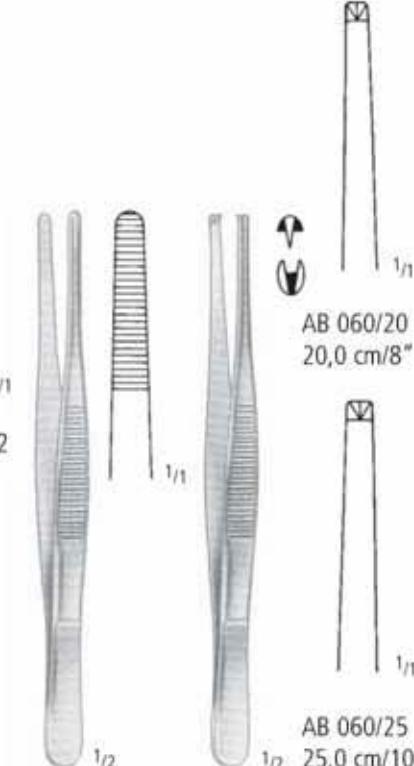

**STANDARD**  
AB 050/20  
20,0 cm/8"

**1:2 STANDARD**

AB 060/20  
20,0 cm/8"

AB 060/25  
25,0 cm/10"

Fig. 2  
AA 221/02  
21,0 cm/8 1/4"

Fig. 1  
AA 223/01  
27,0 cm/10 3/4"

Fig.1  
gebogen  
curved  
curvas  
courbes  
curve



**STANDARD**

AC 011/15  
15,5 cm/6"

**SIMS**

AC 091/20    AC 091/23  
20,0 cm/8"    23,0 cm/9"

**METZENBAUM**

AC 941/18  
18,0 cm/7"

AC 941/23  
23,0 cm/9"

AD 010/04  
No. 4

**MAYO-HEGAR**

AE 400/20  
20,0 cm/8"



**WERTHEIM**

AE 487/24  
24,0 cm/9 1/2"

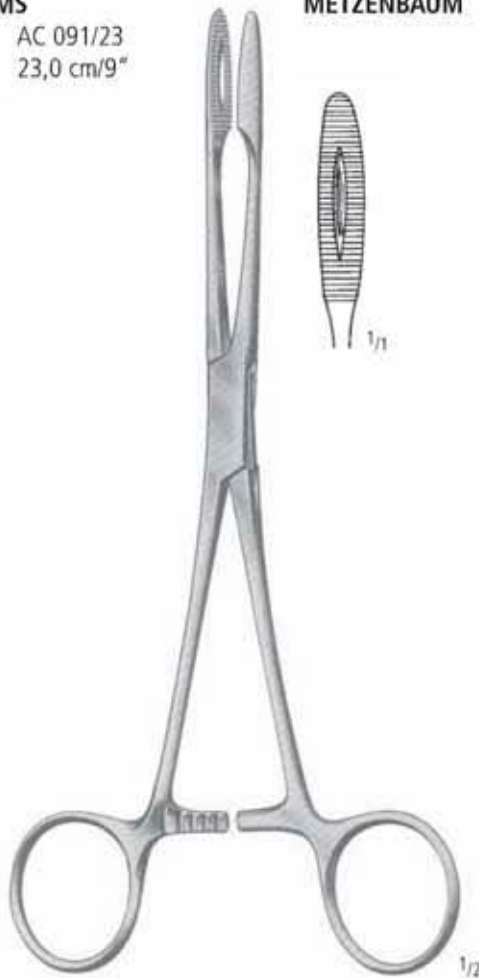

**GROSS-MAIER**

AF 100/27  
27,0 cm/10 3/4"

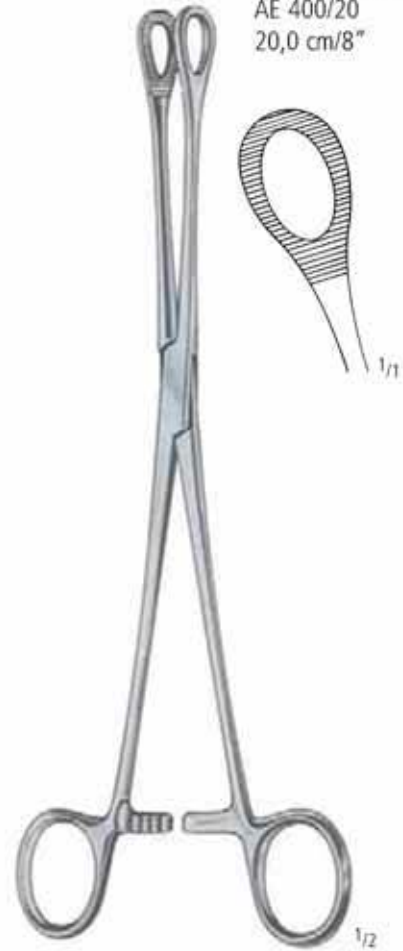

**FOERSTER-BALLEGER**

AF 201/25  
25,0 cm/10"



**MODELL TÜBINGEN**  
AK 239/28  
28,0 cm/11"

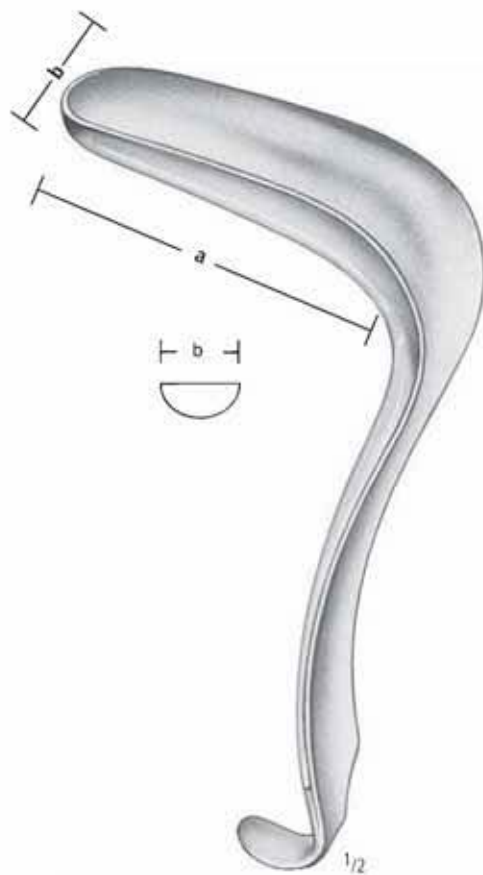

**KRISTELLER**  
**a b**  
Fig. 2 110 x 30 mm KB 062/02



**SCHERBACK**  
400 g = KB 078/40



- KB 078/05 = KB 078/10
- KB 078/11
- KB 078/12
- KB 078/13
- KB 078/14
- KB 078/20
- KB 078/40